

3RD EDITION

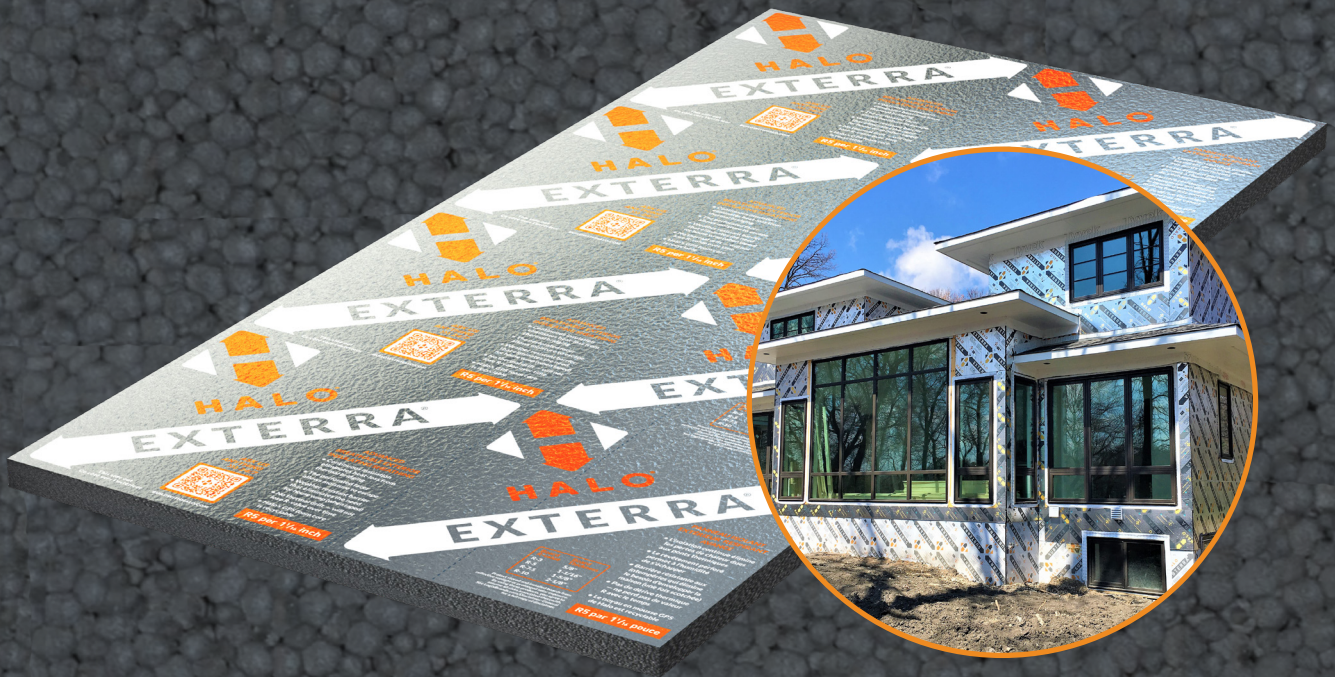

INSTALLATION GUIDE

US & CANADA



CONTINUOUS INSULATION + WEATHER BARRIER

DISCLAIMER

Reference to “Logix Brands Ltd.”, “Logix Insulated Concrete Forms”, and/or “Logix” means the manufacturer (the “Manufacturer”) selling the product(s) (the “Products”) referenced in the Product Specific Table and Accessories section of and detailed within the installation guides throughout this manual (the “Manual”) to consumers (the “User”). The Manufacturer sells its Products “as is” and the contents of the Manual are provided “as is”.

NO EXPRESS WARRANTIES ARE GIVEN. ALL WARRANTIES, EXPRESS, STATUTORY AND IMPLIED, INCLUDING BUT NOT LIMITED TO, WARRANTIES OF MERCHANTABILITY AND FITNESS FOR A PARTICULAR PURPOSE, ARE EXPRESSLY DISCLAIMED.

The User assumes all risks as to the use of the Products and/or the Manual. The Manual is to be used as a reference guide only. The User shall confirm the information contained in the Manual meets local building codes and construction practices by consulting with local building officials and professionals, and determine if there are any additional building and/or construction requirements. Before use, the User should fully investigate the Products to enable informed choices as to suitability for a particular construction project and proper design and implementation. It is the User’s responsibility and obligation to ensure all work performed conforms to applicable building code and labour safety regulations governing the construction.

As the Manufacturer has no control over installation design and workmanship, accessory materials or application conditions, the Manufacturer does not warranty the performance or results of any installation containing the Products and/or derived from the Manual. The User acknowledges that it has not relied upon any representation, condition or warranty made by the Manufacturer or any other person on the Manufacturer’s behalf.

The Manufacturer assumes no responsibility that its Products will be fit for any particular purpose. The Manufacturer will not be liable for any direct, incidental, consequently or indirect damages (including lost profits) arising out of the use of its Products and/or the Manual.

The Manufacturer reserves the right to make changes to the Manual without notice and assumes no liability in connection with the use of the Manual.



1.0 CRITICAL BARRIERS IN A TYPICAL WALL ASSEMBLY WITH HALO® EXTERRA® 5

2.0 – PRACTICES FOR STORAGE & EXPOSURE DURING INSTALLATION..... 6

 2.1 - STORAGE.....6

 2.2 - INSTALLATION.....6

3.0 – TOOLS & MATERIALS7

 3.1 - SEALING JOINTS, PENETRATIONS, PERIMETER EDGES7

 3.2 - FLASHING7

 3.3 - GLUING OR FASTENING7

 3.4 - CUTTING.....8

4.0 - PRODUCT DESCRIPTION 9

 4.1 - FEATURES9

 4.1.1 - WATER CONTROL LAYER (WEATHER RESISTIVE BARRIER)9

 4.1.2 - THERMAL CONTROL LAYER (CONTINUOUS INSULATION)10

 4.2 - BENEFITS10

 4.3 - AVAILABLE BOARD SIZES11

5.0 – APPLICATION.....12

6.0 - INSTALLATION12

 6.1 - FRAMED WALLS WITH WOOD SHEATHING.....12

 6.2 - FRAMED WALLS WITHOUT WOOD SHEATHING.....12

 6.2.1 - DIAGONAL BRACING13

 6.2.2 - CORNER BRACING WITH WOOD OR GYPSUM SHEATHING.....13

 6.2.3 - INSULATED WOOD SHEATHING BRACING.....14

 6.3 - OVER CONCRETE OR MASONRY WALLS.....14

 6.4 - SEALING JOINTS AND FASTENER PENETRATIONS15

 6.4.1 - PENETRATIONS16

 6.5 - WINDOW AND DOOR OPENINGS.....18

 6.6 - TRANSITIONS20

 6.6.1 - FOUNDATION TRANSITION TYPICAL DETAIL EXAMPLES20

 6.6.2 - ROOF TRANSITION TYPICAL DETAIL EXAMPLES21

 6.7 - CLADDING.....22

 6.7.1 - CLADDING OVER EXTERRA WITHOUT WOOD STRAPPING23

 6.7.2 - CLADDING OVER EXTERRA WITH WOOD STRAPPING23

 6.7.3 - CAVITY WALLS24

7.0 - FASTENERS.....25

 7.1 - TYPICAL NAILING PATTERNS OVER WOOD SHEATHING & DIRECT TO STUD ASSEMBLY25

 7.1.1 - OVER WOOD SHEATHING.....26

 7.1.2 - DIRECT TO STUD ASSEMBLY28

 7.2 - NAILING PATTERNS FOR PREFABRICATED WALL ASSEMBLIES33

 7.3 - RECOMMENDED FASTENER LENGTHS38

 7.3.1 - OVER WOOD SHEATHING38

 7.3.2 - DIRECT TO WOOD STUD ASSEMBLY38

 7.4 - FASTENER AND STRAPPING TABLES.....39

 7.5 - FASTENER REQUIREMENTS FOR WIND LOADS - EXTERRA DIRECT TO WOOD STUDS40



8.0 - INSPECTION & REPAIRS 41

9.0 - EXAMPLE CAD DETAILS 42

 9.1 - FLANGED WINDOW INSTALLED AGAINST WOOD SHEATHING 43

 9.2 - FLANGED WINDOW INSTALLED AGAINST EXTERRA..... 44

 9.3 - ROOF TRANSITION 45

 9.4 - TYPICAL WALL ASSEMBLY 46

 9.5 - FLOOR TRANSITION 47

 9.6 - FOUNDATION TRANSITION..... 48

For more information, or to contact a Halo representative, call 1-855-350-4256 (HALO), or e-mail info@BuildWithHalo.com.

This manual will be updated regularly. Current updates will be available at www.BuildWithHalo.com.





1.0 CRITICAL BARRIERS IN A TYPICAL WALL ASSEMBLY WITH HALO® EXTERRA®

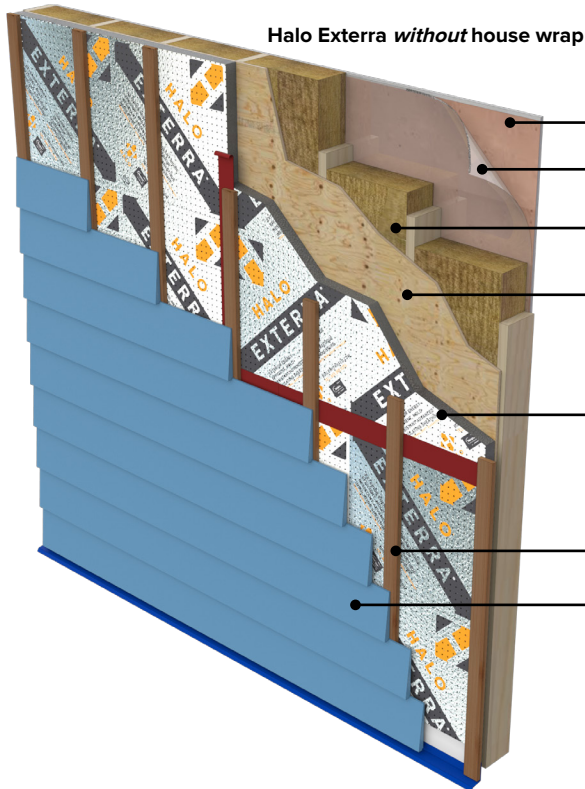

Halo Exterra *without* house wrap

- Gypsum board
- Polyethylene membrane or variable vapor permeance membrane (*VAPOR RETARDER*)
- Wood studs with cavity insulation
- Wood sheathing (optional)

*Halo Exterra with taped joints (*WATER RESISTIVE BARRIER and CONTINUOUS INSULATION*)

Note.: Any fastener that breaks the surface of the laminate must be sealed with tape or sealant to maintain water resistive barrier

- 1 x 3 wood strapping
- Cladding

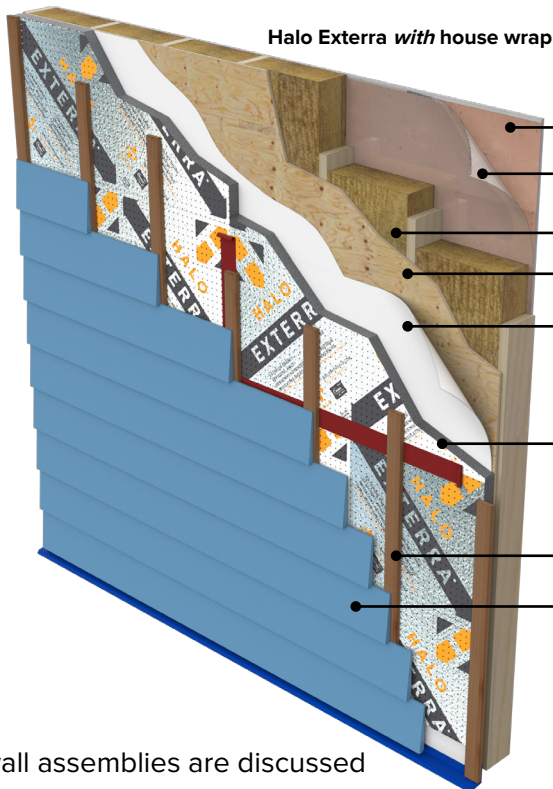

Halo Exterra *with* house wrap

- Gypsum board
- Polyethylene membrane or variable vapor permeance membrane (*VAPOR RETARDER*)
- Wood studs with cavity insulation
- Wood sheathing (optional)

— Sheathing membrane (*AIR BARRIER & OPTIONAL WEATHER*)

*Halo Exterra with taped joints (*WATER RESISTIVE BARRIER and CONTINUOUS INSULATION*)

Note.: Any fastener that breaks the surface of the laminate must be sealed with tape or sealant to maintain water resistive barrier

- 1 x 3 wood strapping
- Cladding

* Alternative wall assemblies are discussed throughout the Installation Guide.





2.0 – PRACTICES FOR STORAGE & EXPOSURE DURING INSTALLATION

External factors, such as solar energy conveyed via reflective surfaces under clear packaging can create excessive heat build-up within insulation products made of graphite polystyrene (GPS) foam. Excessive heat-build-up can damage the insulation. Precautionary measures taken in the storage and installation of the insulation products can greatly help to minimize the potential for damage.

2.1 - STORAGE

When storing insulation products on the job site care should be taken to keep exposed foam protected from reflected sun light or prolonged solar exposure. Packaging products are shipped with UV-resistant properties. Always keep Halo products tarped or covered to protect from weather. Avoid using clear plastic covering film or tape. Store indoors if possible.

2.2 - INSTALLATION

Until cladding is installed over Exterra the following recommendations will help ensure installed Halo products are restored to its original dimensions in the event of thermal expansion, and minimize damage due to reflective sunlight or prolonged solar exposure.

- Remove or cover the surface that is casting a reflection on installed Halo products, or shield the affected Halo products.
- Cover the Exterra laminate, as its printing may fade if exposed for over 30 days. Faded printing is normal and will not degrade the Halo properties. Protect Exterra at the first signs of peeling or degradation of the laminate, or if exposure is expected to exceed 30 days.
- Ensure all butt joints are tightly fitted.
- Immediately tape seal or temporarily cover all joints of inside corners until tape sealant is applied. Edges of Subterra products installed on subgrades and adjacent to Exterra should also be immediately covered until proper sealant method is applied along the perimeter between Exterra and Subterra.





3.0 – TOOLS & MATERIALS

For confirmation of compatibility for alternative tapes, sealants or adhesives not listed below, please call 1-855-350-4256 (HALO), or e-mail info@BuildWithHalo.com”.

3.1 - SEALING JOINTS, PENETRATIONS, PERIMETER EDGES

- Perma R® Products Sheathing Tape
- Henry® Sheathing and Commercial Tape
- FastFlash® by Prosoco®
- Conexo® by Partel®
- Wigluv® by Siga®
- Tescon Vana by Pro Clima®
- Vapor barrier blue or red Tuck® Tape
- Blueskin® flashing tape and
- Great Stuff™ Insulating Foams or equivalent*
- HydroFlash GP by Benjamin Obdyke
- HydroFlash LA by Benjamin Obdyke
- XL Flash by Pecora
- Delta Multi-Band by Dorken

* Use for gaps greater than 1/8” (3 mm) or greater. Not recommended to function as the water or air seal when used with Halo Exterra

3.2 - FLASHING

- Perma R® Products PermaTak™
- Perma R® Products ProTak™
- Extoseal® Encors by Pro Clima®
- Dorken Delta®-Flashing
- Dorken Delta®-LFS
- FastFlash® by Prosoco®
- Henry® FortiFlash®
- Henry® Air-Bloc LF® Liquid Applied Flashing
- Henry® Moistop neXT®
- Henry® Blueskin® Butyl Flash
- 3M™ Ultra Conformable Flashing Tape 3015UC
- HydroFlash GP by Benjamin Obdyke
- HydroFlash LA by Benjamin Obdyke
- XL Flash by Pecora





3.3 - GLUING OR FASTENING

- Weather resistive construction glue, such as PL® 300
- Plastic or metal cap washer min. 1" (25mm) diameter with screw or nail min. 1" (25mm) penetration depth into framing member.

When fastening to metal studs use self-drilling screws with at least 1" diameter metal washers.

3.4 - CUTTING

- Hand saw
- Jig saw
- Utility knife and T-square
- Circular saw
- Table saw
- Reciprocating saw





4.0 - PRODUCT DESCRIPTION

4.1 - FEATURES

Halo Exterra is a rigid foam insulated sheathing for above-grade walls that is faced with a perforated polypropylene laminate on both sides. The perforated facer allows moisture to dry towards the exterior of the wall assembly. The insulation is made with graphite polystyrene (GPS) which is expanded polystyrene infused with graphite particles. Insulation made with GPS provides up to 18% more thermal resistance than conventional expanded polystyrene insulation (EPS).

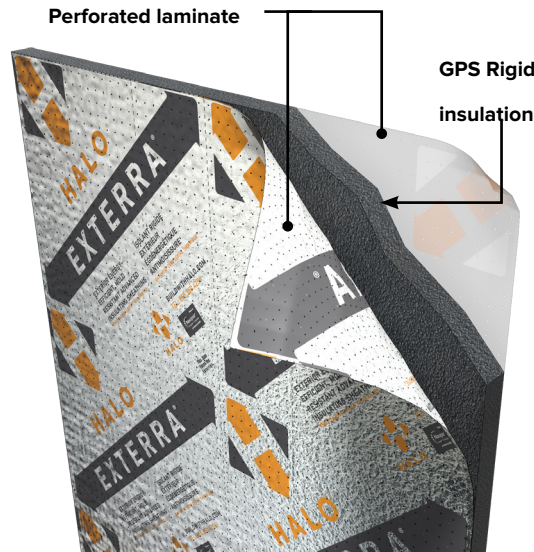

Halo Exterra rigid insulation board

4.1.1 - Water Control Layer (Weather Resistive Barrier)

North American building codes and good building science practices, require a second plane of protection behind the cladding that is integrated with the assemblies flashing details to dissipate liquid water to the exterior.

This plane of protection is referred to as the water control layer or weather resistive barrier (WRB). The objective of this control layer is to prevent liquid water from entering the wall assembly and provide a surface that allows the water to drain out and away from the building.

When the joints of Halo Exterra are sealed and the foam sheathing has been integrated into the assemblies flashing details then it is permitted to function as the water control layer¹. An additional membrane (mechanically fastened, peel and stick or liquid applied) is not required behind or in front of Halo Exterra when the joints of Halo Exterra have been sealed. However, a membrane with the appropriate vapor permeance based on the project's climatic zone may be placed behind or in front of Halo Exterra without affecting the performance attributes of the product.

NOTE: Any fastener that breaks the surface of the laminate must be sealed with tape or sealant to maintain water resistive barrier.





4.1.2 - Thermal Control Layer (Continuous Insulation)

An effective way to lower the energy consumption, provide increased levels of comfort, and improve the durability of a building is to move insulation from between wood or steel studs or place a portion of the insulation on the exterior of the building enclosure in the form of continuous insulation.

Thermal bridges from framing members can be reduced with a layer of exterior continuous insulation. The insulation will help to prevent heat loss or gain through the framing member, which will lower the energy required to maintain interior conditions for the building occupants.

The reduction of thermal bridges will also help to ensure surfaces remain at a constant temperature. This will limit building occupants losing or gaining radiant energy from hot or cold surfaces yielding improved levels of comfort.

The addition of exterior continuous insulation to an above grade wall assembly also helps to keep the air behind the foam board insulation at a higher temperature. The benefits of air at a higher temperature means it can hold more moisture. Since the air behind the continuous insulation is at a higher temperature there is less of a chance for condensation to occur (DEW point temperature reached) within the walls above grade due to air leakage across the assembly.

4.2 - BENEFITS

The following benefits can be achieved for an above grade wall assembly when Halo Exterra has been installed on the exterior of the building enclosure:

- Reduction in thermal bridging from framing members.
- Achieve an increase in effective thermal resistance compared to cavity insulation alone.
- Helps to keep first condensation plane at a higher temperature, which can reduce the risk of condensation.
- Acts as the water control layer when sealed at joints and fastener penetrations, eliminating the need for additional membranes, such as house wrap.¹
- Vapour permeable and non-permeable product offerings (allows assembly to dry in cold climate or blocks moisture intrusion in a warm and humid climate)².
- Reduces heat gains in warm climates when an air gap is provided between Exterra and the cladding (applicable only where Exterra is available with a reflective laminate).

1. Minimum thickness required for Halo Exterra to function as the water control layer (WRB) is 9/16" or greater.
2. Permits drying to the exterior at maximum Halo Exterra thickness of 2 inches.





4.3 - AVAILABLE BOARD SIZES

Available in 4ft x 8ft sheets, ranging in thicknesses as shown in Table 1. Custom sizes and thicknesses are also available. Contact your local Halo representative for availability.

Table 1: Available Board Sizes

Board Thickness	Board Size
1/2" (12.5 mm)	4' x 8' (1220 mm x 2438 mm)
9/16" (14 mm)	
5/8" (15.8 mm)	
1" (25.4 mm)	
1 1/2" (38 mm)	
2" (50.8 mm)	
2 1/8" (54 mm)	

Note: Minimum thickness required for Halo Exterra to function as the water control layer (WRB) is 9/16" or greater.





5.0 – APPLICATION

Suitable for use in new construction, renovations, and retrofits, Halo Exterra is designed to provide stable long term continuous insulation and function as the WRB when joints are sealed for exterior above grade walls in residential, multi-residential, commercial, and industrial buildings with the added benefit of allowing the wall assembly to dry towards the exterior.

6.0 - INSTALLATION

The following information and illustrations are the recommended installation requirements for Halo Exterra. It is advised that the customer ensures all installation requirements noted in this guide meet the minimum requirements of the local building code.

Installations may vary depending on project specific requirements, in these applications please consult the Logix Brands technical representative.

NOTE: Where Exterra is manufactured with a reflective laminate on one side only, it is recommended the reflective laminate faces towards the exterior.

6.1 - FRAMED WALLS WITH WOOD SHEATHING

Halo Exterra is permitted to be secured directly to wood sheathing if the wood sheathing meets the minimum thickness required by the local building code. A 1/2" (13mm) diameter plastic or metal cap nail or screw is recommended to secure Exterra to the wood sheathing. The penetration depth of the nail or screw into the wood sheathing shall comply with Table 1 in section "7.3.1 - Over Wood Sheathing" on page 38

6.2 - FRAMED WALLS WITHOUT WOOD SHEATHING

Halo Exterra is not a structural sheathing material. Depending on the local building code bracing may be required to resist dead, live, service, or construction loads.

It may be acceptable to install Halo Exterra directly over wall studs when the interior finish is one of the following; gypsum board with taped joints, plywood, hardboard, insulating fibreboard, particleboard, waferboard, or strandboard. Check with local building codes to ensure compliance.

Please note there will be a requirement for a specific fastener type, spacing, and penetration when an insulated sheathing is installed directly over top of the wall studs. Generally, this practice is acceptable when bracing requirements to resist lateral loads due to wind and earthquake are low to moderate. High and extreme wind and earthquake forces will require design by a professional engineer.

For minimum embedment lengths direct to wall studs, refer to Table 2 in "7.3.2 - Direct To Wood Stud Assembly" on page 38.





6.2.1 - Diagonal Bracing

To aid in racking strength as the building is erected, it is recommended to include a metal t-brace saw cut into the wall studs and placed at a 45 degree angle or steeper.

Temporary bracing is required as the building is being framed and should not be removed until the interior finish has been installed. Remove temporary bracing floor by floor and immediately apply interior finish. Do not remove temporary bracing without application of interior finish.

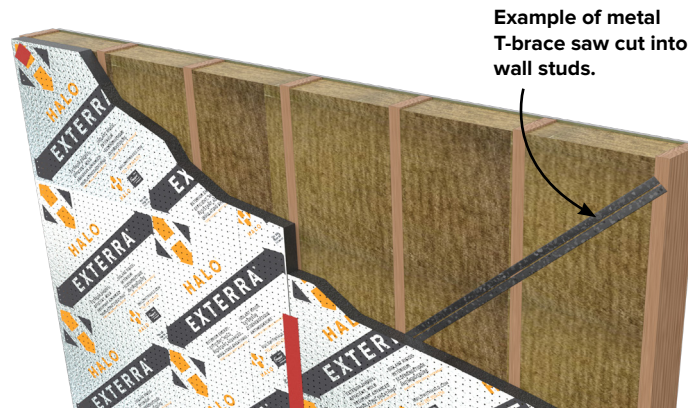

Example of metal T-brace saw cut into wall studs.

6.2.2 - Corner Bracing With Wood or Gypsum Sheathing

Exterra is installed over the entire home after the structural sheathing is installed as corner bracing. The panels add thickness to the framed wall at the corner regions so Exterra will be thinner over the sheathing than areas without sheathing. This ensures the exterior face of Exterra remains flush along the walls.

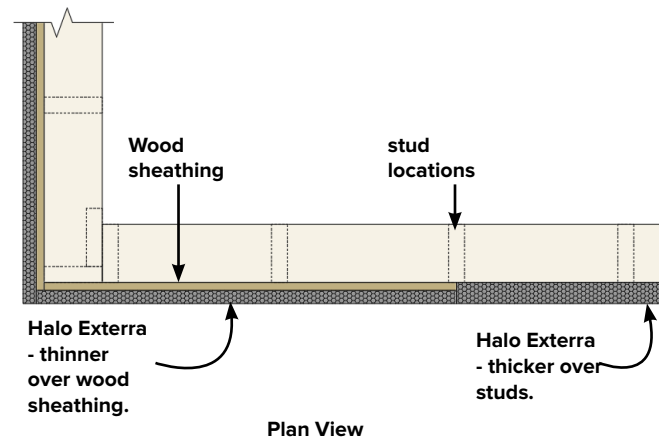
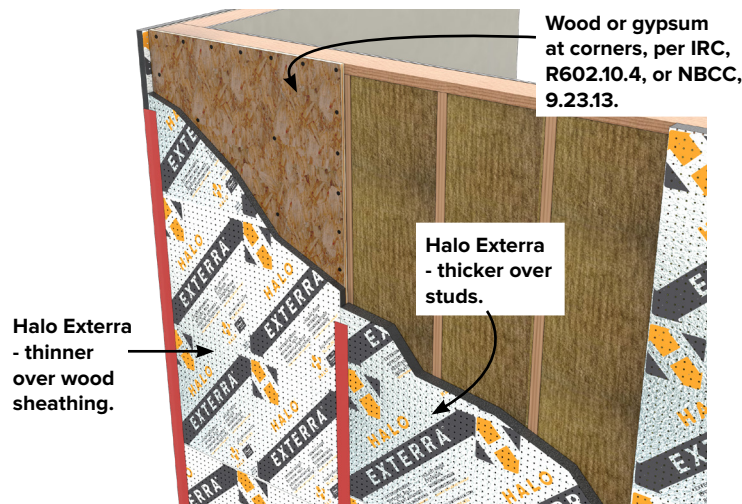



6.2.3 - Insulated Wood Sheathing Bracing

Insulated wood structural panels used as corner bracing offers continuous insulation built into the structural sheathing. In this case, Exterra is not required over the structural panel but should be thick enough to match the thickness of the structural sheathing and its underlying insulation layer throughout the entire wall.

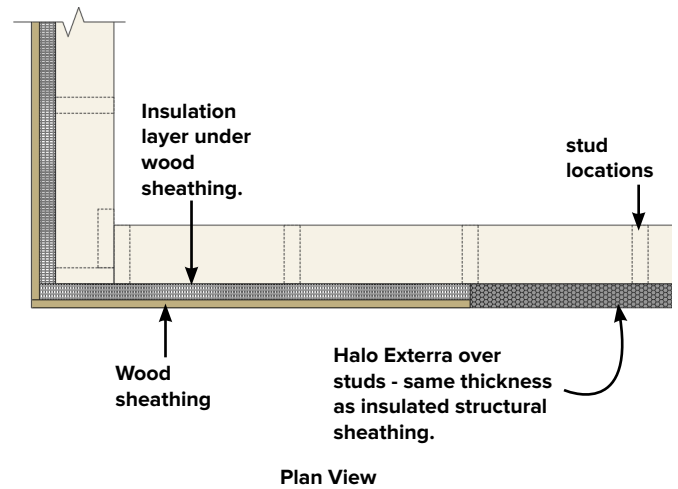
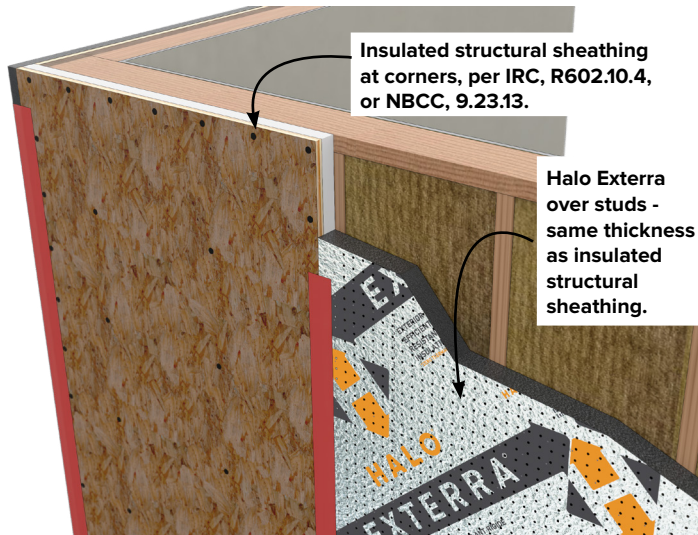

INSTALLATION GUIDE

6.3 - OVER CONCRETE OR MASONRY WALLS

Use weather resistant construction glue compatible with expanded polystyrene, such as PL 300, to secure Exterra sheets to the wall. If the wall is too rough or uneven concrete screws with washers or insulations pins (Insulfast by ITW, Thermal-Grip Insulation Pins by TruFast Walls, X-IE 6 Insulation Fastener by Hilti or equivalent) can be used along with adhesives to help secure the sheets.

Use weather resistant construction glue compatible with expanded polystyrene, such as PL 300, to secure Exterra to the wall.

If the wall is too rough or uneven concrete screws with washers, InsulFast clips or similar, can be used along with adhesives to help secure Exterra.

Any fastener that breaks the surface of the laminate must be sealed with tape or sealant to maintain water resistive barrier.

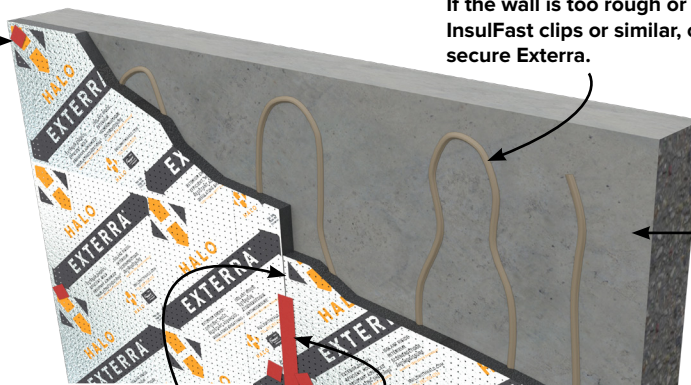

Ensure butt edges fit tightly with no gap.

Seal all joints to allow Halo Exterra to function as the water resistive barrier





6.4 - SEALING JOINTS AND FASTENER PENETRATIONS

To allow Exterra boards to function as the water resistive barrier, board joints and fastener penetrations that break through the facer layer should be sealed with a tape or liquid applied sealant. If joints and penetrations are not sealed then a separate water-resistive barrier must be applied preferably between Exterra and the wood sheathing, but can also be placed on top of Exterra.

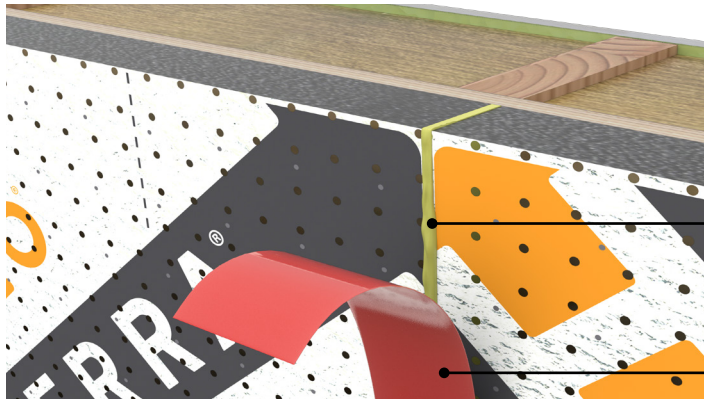

Ensure there is a tight fit between boards and any gap larger than 1/16" (1.59 mm) should be filled with low expansion spray foam sealant.

Seal all butt edge joints with tape or liquid applied sealant

Seal all fastener penetrations when the laminate surface has been broken with tape or liquid applied sealant

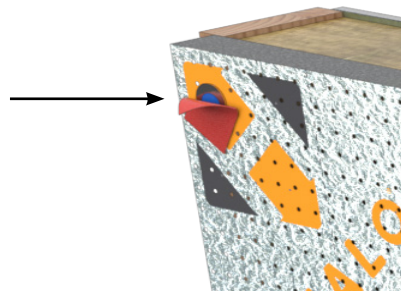



6.4.1 - PENETRATIONS

Halo Exterra can be cut with a utility knife, circular saw, reciprocating saw, or hole saw, etc. Care should be taken to ensure a tight fit around penetrations.

The following illustrations provide examples of how to seal a penetration through Exterra in order to maintain continuity of the water resistive barrier.

Step 1: Cut a rough opening.

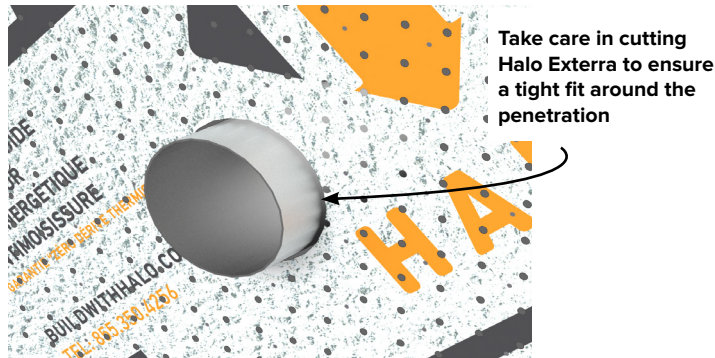

Step 2: Apply spray foam to fill gaps, as required.

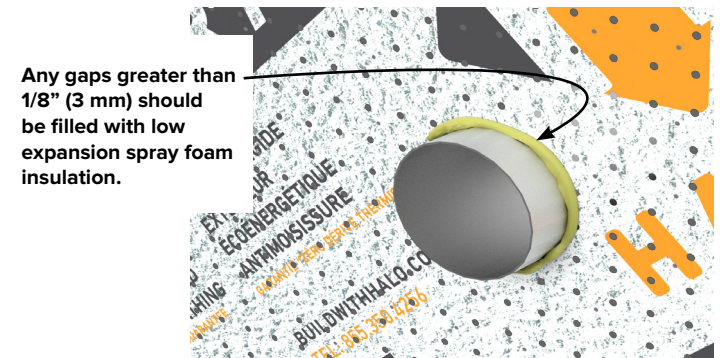

Step 3: Apply self-adhered membrane, tape or liquid applied sealant to the bottom of the penetration

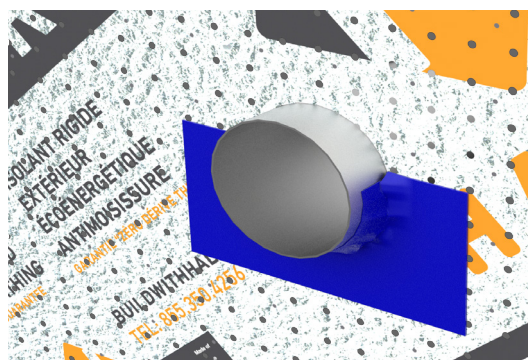

Step 4: Apply self-adhered membrane, tape or liquid applied membrane to the top of the penetration.

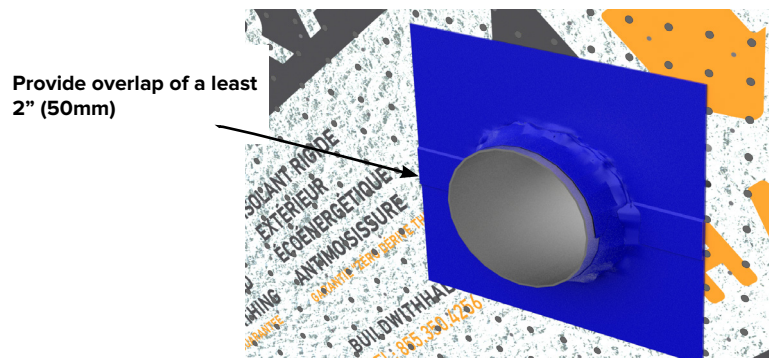

Step 5: Apply sheathing tape at outer edges. If liquid applied membrane is used then no further steps are required after Step 4.

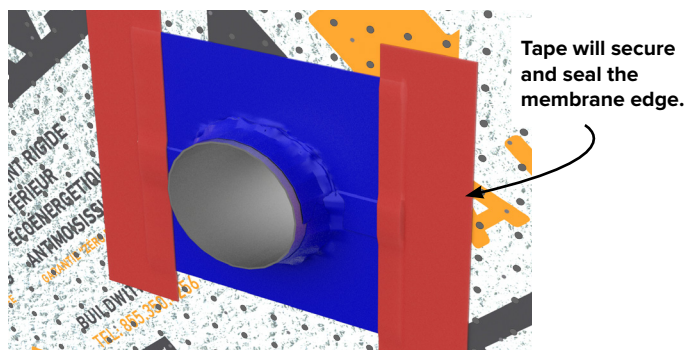

Step 6: Install trim block.

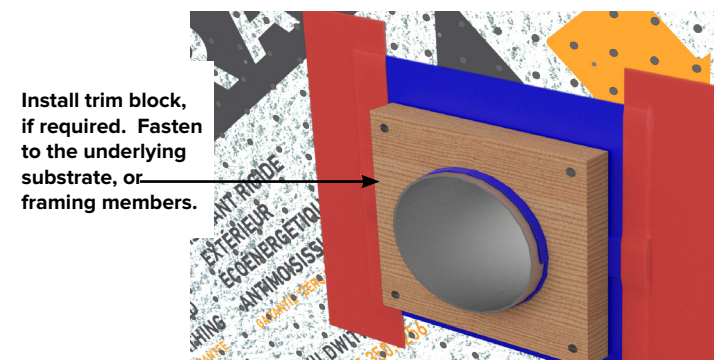

INSTALLATION GUIDE





Step 7: Install flashing.

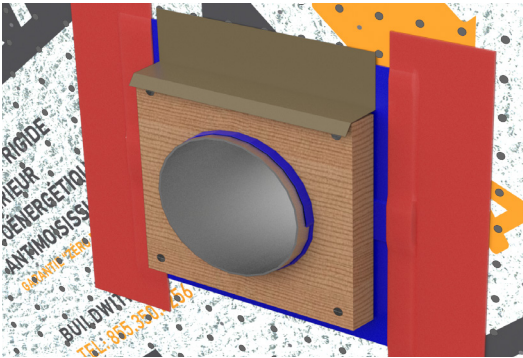

Step 8: Apply tape or liquid applied sealant to seal flashing to Exterra.

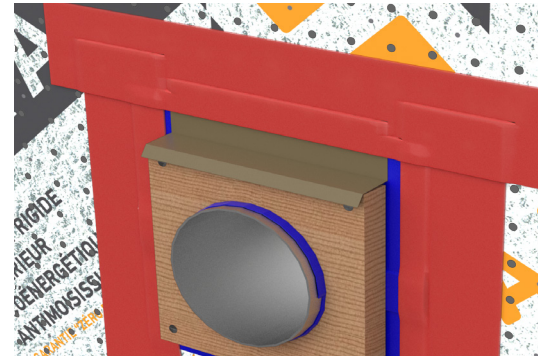

Step 9: Fasten cover to trim block.

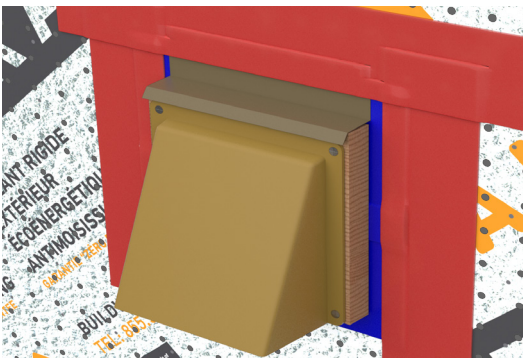



6.5 - WINDOW AND DOOR OPENINGS

The following illustrations provide a best practice example for addressing water management with a window or door opening. The minimum building code requirement may be less than what is noted below, however, Logix Brands strongly recommends implementing this best practice to limit water penetration.

Step 1: Cut out Halo Exterra to match the rough opening. Prior to the installation of the sill membrane, the sill should incorporate a back dam and sloped towards the exterior.

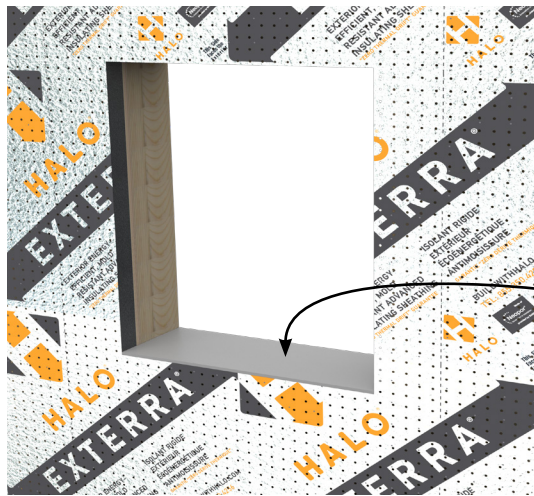

Install back dam and sloped sill.

Install a vertical section of the membrane a minimum of 8" up the jamb. Extend min. 4" (100mm) on to the face of Exterra.

Step 2: Apply a self adhered membrane, tape or liquid applied sealant to the bottom sill and extend a minimum of 8" (200 mm) up the jamb. This is the minimum level of detailing suggested from a best practice standpoint prior to the installation of the window or door.

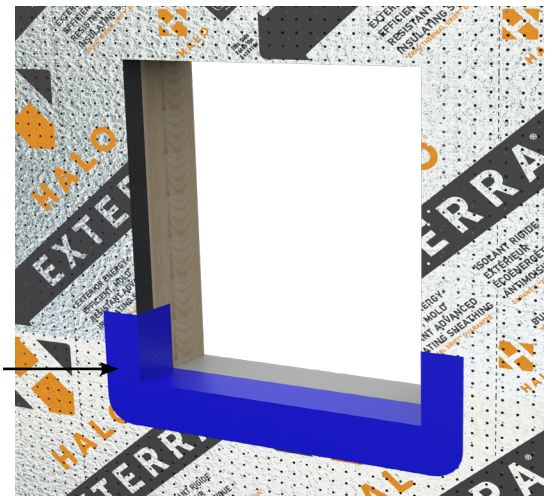

Step 3: To provide additional protection to the rough opening from water penetration self adhered membrane, tape or liquid applied sealant can be applied to the entire vertical jambs as well as the header.

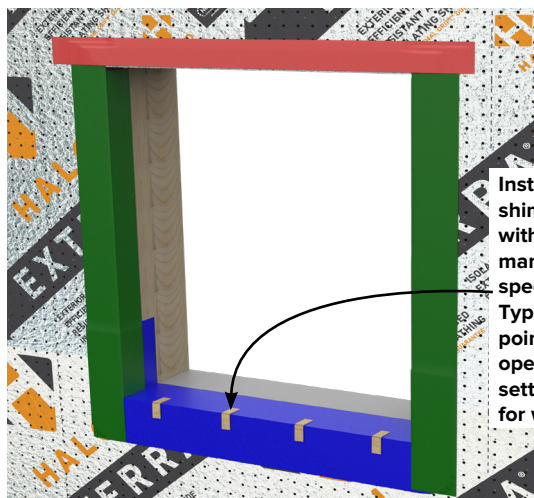

Install window shims in accordance with window manufacturer's specifications. Typically at quarter points of rough openings and under setting block locations for window.

Step 4: Install flanged or boxed window and fasten to the structure as recommend by the window manufacture. For flanged windows it is suggested to shim out the bottom flange to assist in drainage of water from around the rough opening.

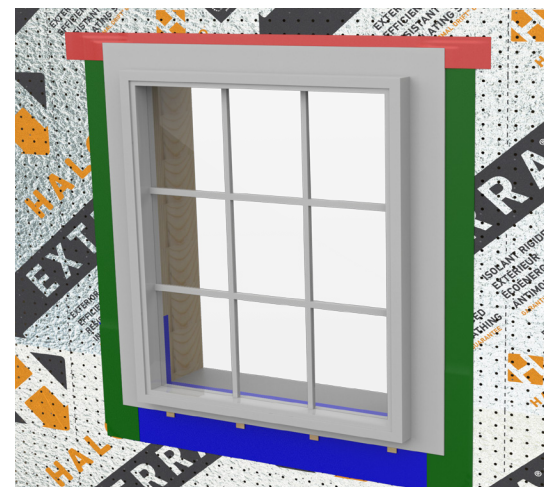



Step 5: Install self-adhering, tape or liquid applied sealant around vertical jamb and header that extends at minimum 2" (50 mm) onto the face of the exterior sheathing. Ensure bottom sill is not sealed to allow water to drain out from the rough opening.

Step 6: Install header flashing and seal with self-adhered, tape or liquid applied sealant.

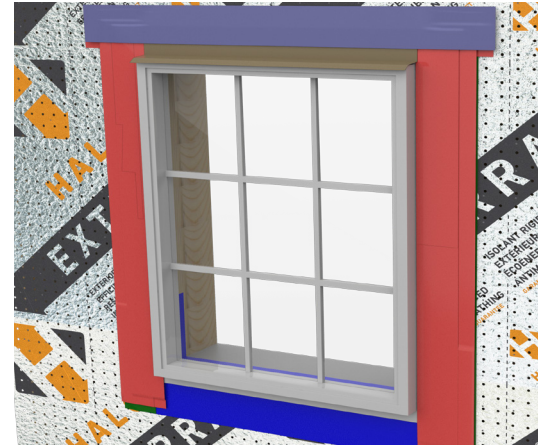
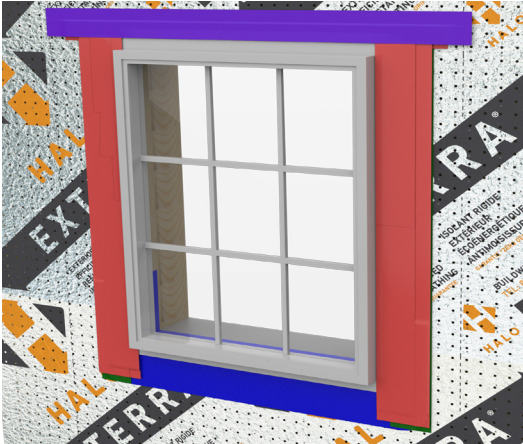

Step 7: if required, install furring strips around the opening.

Step 8: Install trim boards and/or finished cladding

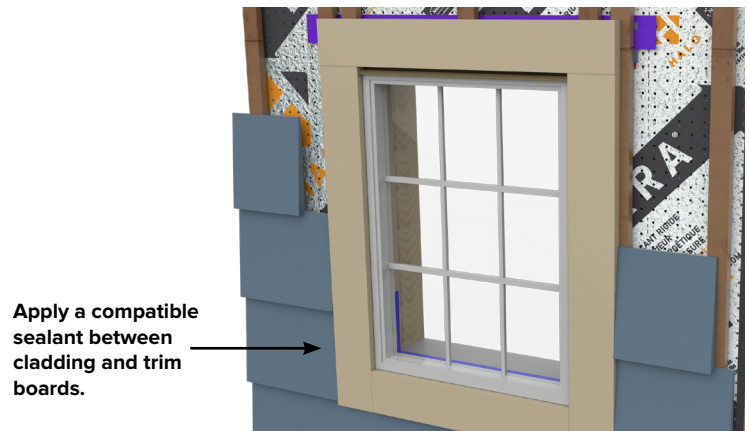
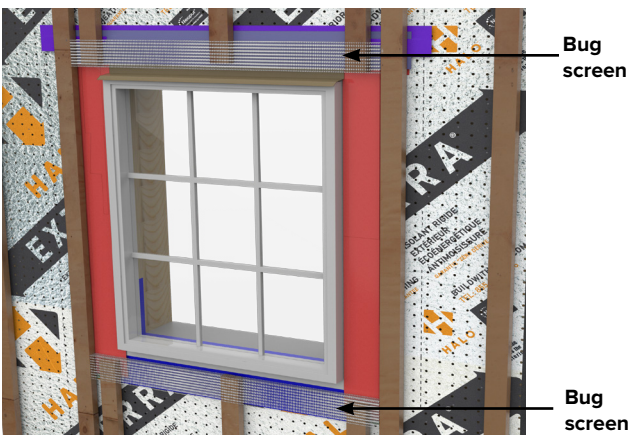

Step 9: Interior air and water seal.

Install foam backer rod around entire interior perimeter of window to facilitate proper sealant joint profile. Apply and tool liquid applied sealant or low expansion spray foam sealant around full perimeter of window in proper 2:1 joint profile. Install interior jamb if required and fill with insulation.

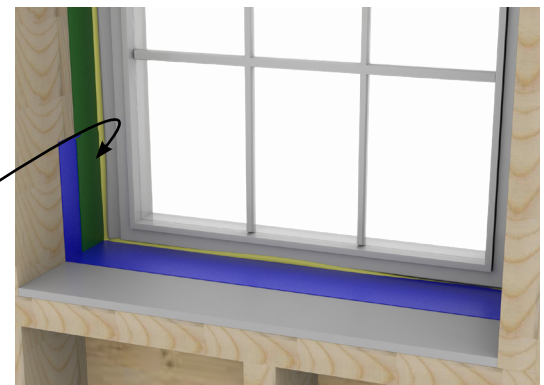



6.6 - TRANSITIONS

To ensure the water resistance barrier stays continuous and the above-grade wall assembly effectively drains water away from the building, the following examples highlight best practices. Note that specific details may differ depending on the project-specific requirements, climatic zone, or local building code requirements.

6.6.1 - Foundation Transition Typical Detail Examples

Fasten flashing over Exterra and apply self-adhering membrane at termination.

Flashing

Trim board

Foundation wall

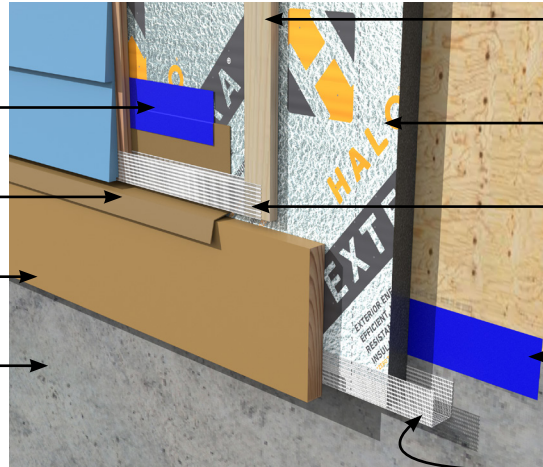

Foundation transition detail with trim board

If required, install wood strapping against Exterra.

Seal all Exterra joints and penetrations.

Install bug screen at termination ends of wood furring strips.

Seal wood sheathing to top of foundation wall with tape or liquid applied sealant

Install bug screen at termination ends of Exterra.

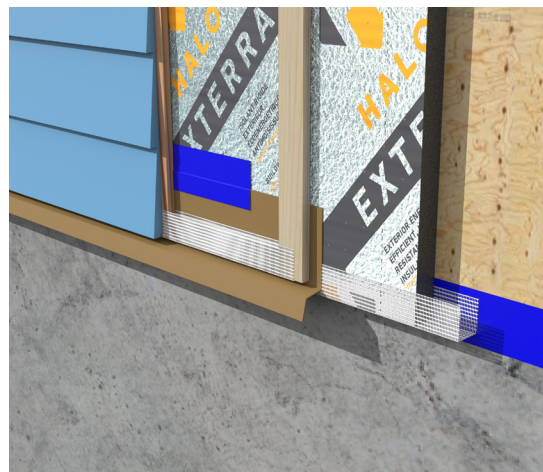

Foundation transition detail without trim board





6.6.2 - Roof Transition Typical Detail Examples

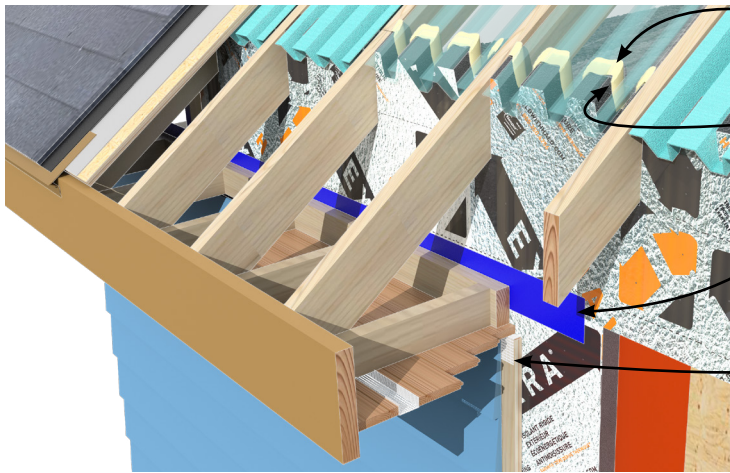

- Spray foam.
- Cut Exterra to underside of the roof baffles.
- Apply spray foam at termination.
- Seal all Exterra joints and penetrations.
- Install bug screen at termination ends of wood furring strips.

Roof transition detail: Exterra extending to underside of roof baffles



- Optional exterior air barrier (mechanically fastened membrane, peel and stick membrane, or liquid applied membrane, must be detailed to remain continuous throughout building).

Roof transition detail: Exterra extending flush to top sill plate





6.7 - CLADDING

Preventing the intrusion of rain water into the building enclosure is the single most important factor in the design and construction of durable buildings. In short, all exterior cladding types will allow the passage of some rainwater. Drainage plans are used in behind the cladding to direct water down and outwards from the building.

In order for drainage of rainwater to occur there has to be a gap between the back face of the cladding and the front face of the weather resistive barrier. This drainage space can be as small as 1/16" (2 mm). However, if a drainage and ventilation space is desired the space between the two materials may need to be 3/4" (19 mm) minimum depending on the moisture load.

As a best practice Logix Brands recommends the installation of furring strips when installing cladding over top of Halo Exterra. Nails or screws can be used to secure furring strips back to the wood studs or if wood sheathing is present and of sufficient thickness directly to the sheathing. Penetration depth into either material should be at least 1" (25 mm).

It is permissible to install cladding directly on top of Halo Exterra, however, this should be verified with the cladding manufacturer, local building code requirements and local building science best practices.

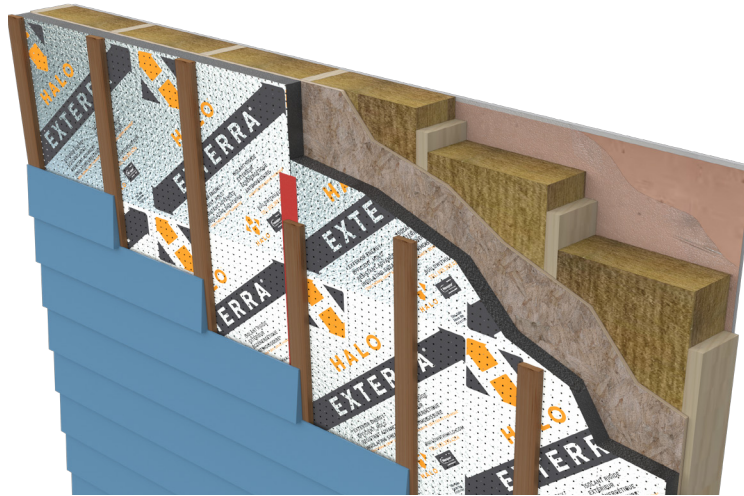

Fasten cladding to the substrate, or if required to the wood furring strips. See "7.0 - FASTENers" on page 25.

Where Exterra is available with a reflective or white laminate on one side of the insulation it is recommended that Exterra is installed with these laminates facing the exterior.

INSTALLATION GUIDE





6.7.1 - Cladding Over Exterra Without Wood Strapping

When attaching cladding without wood strapping, nails or screws should penetrate Exterra and significantly penetrate the wood sheathing or stud, as specified by the cladding manufacturer. Ensure the wood sheathing is thick enough to resist lateral and pull-out loads. Check local building codes for minimum sheathing thickness requirements.

If wood sheathing is absent or lacks strength, fasteners should fasten into the framing members. Ensure nails or screws penetrate Exterra and at least 1" (25 mm) into the framing studs or blocking between studs.

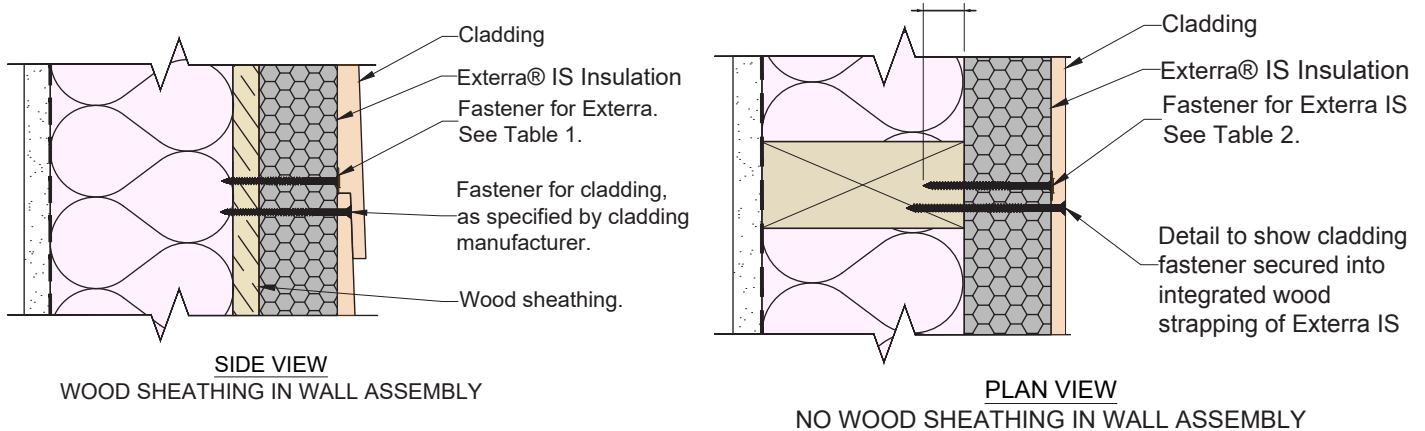

6.7.2 - Cladding Over Exterra With Wood Strapping

When using wood strapping over Exterra, the cladding will be fastened to the strapping.

- Wood Strapping Size:**
 Minimum ¾" thick. 1x3 wood strapping is recommended as a minimum size and for applications of thicker exterior insulation the size of the strapping member may need to be increased. Please consult the local Logix Brands technical representative for further assistance on thick exterior insulation applications.
- Wood Strapping Location:**
 Place vertically to ensure drainage and ventilation path is maintained. For applications where horizontal strapping is required by the siding, first install vertical strapping then install horizontal strapping on top to maintain the drainage and ventilation pathway. Spacing of the strapping is typically 16" (410 mm) or 24" (610 mm).
- Fastener Types and lengths can be found in Table 3 in "7.4 - Fastener And Strapping Tables" on page 39.**
 Screws should be long enough to penetrate wood strapping, Exterra, and at least 1" into the framing studs or sheathing that is sufficiently thick.
- Attach cladding to wood strapping.** Ensure the nails or screws fully penetrate the strapping.



6.7.3 - Cavity Walls

A cavity wall assembly can be installed over top of Halo Exterra as long as a gap of at least 1" (25mm) is maintained from the back face of the cladding to the front face of the exterior insulation. Please consult local building codes to determine the minimum gap requirement based on geographical region in North America.

The cladding can be supported vertically and horizontally up and along the wall assembly with masonry ties. The spacing and fastener used to secure the masonry tie must follow the manufactures specifications. Acceptable masonry tie manufactures include:

- Fero Corporation
- Heckmann Building Products
- Hohmann & Barnard
- Dayton Superior
- Blok-Lok
- TruFast Walls

Contact your local Logix Brands technical representative for alternative masonry ties.

Fasteners for masonry ties must penetrate the Halo Exterra layer and into the wood sheathing or stud at a minimum penetration depth as specified by the masonry tie manufacture.

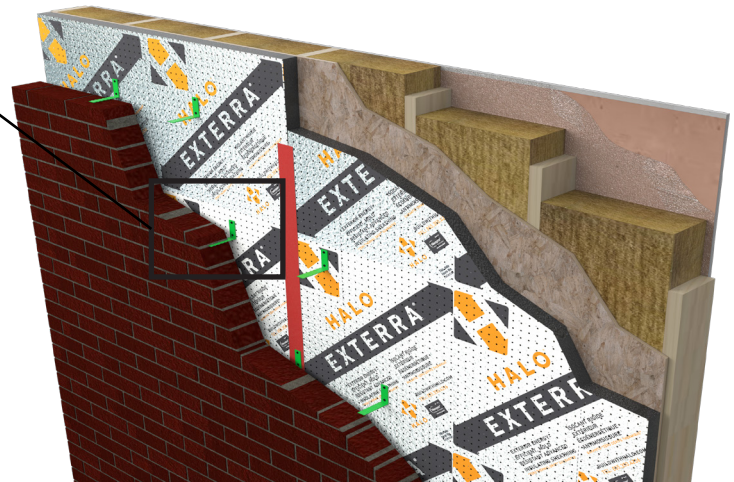
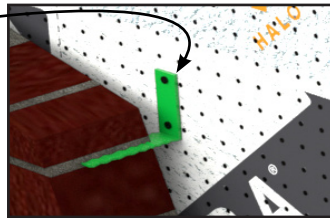



7.0 - FASTENERS

Halo Exterra is not a structural sheathing and therefore a minimal number of fasteners are required to tack the foam board insulation in place. Attachment of cladding and/or strapping will fully secure the insulation board.

It is recommended to secure Halo Exterra with a nail or screw that features a min. 1" (25 mm) diameter head that is set flush with the facer of the insulation boards.

Examples of acceptable fasteners include:

- Plastic cap nails with min. 1" (25 mm) cap and enough nail length to penetrate 1" (25 mm) into the framing
- Roofing nails with min. 1" (25 mm) diameter metal washers
- Wood screw with min. 1" (25 mm) diameter metal washers

When securing Halo Exterra to metal or steel studs select a screw with min. 1" (25 mm) diameter metal washer

7.1 - TYPICAL NAILING PATTERNS OVER WOOD SHEATHING & DIRECT TO STUD ASSEMBLY

The following provides suggested nailing patterns when installing Exterra over wood sheathing or direct to wood studs. Guide lines printed on the Exterra boards can be used to locate studs and fastening points.

To maintain the water resistive barrier and continuous insulation properties all fasteners (that breaks the surface of the laminate) and joints should be covered with tape or liquid applied sealant. In addition, gaps larger than 1/16" (2 mm) should be filled with low expansion foam insulation and then covered with tape, membrane, or liquid applied sealant.





7.1.1 - Over Wood Sheathing

Halo Exterra can be secured to wood sheathing provided the sheathing is of sufficient thickness. Please consult local building code to determine minimum wood sheathing thickness.

Exterra can be placed either horizontally or vertically without the need to stagger vertical joints in a running bond pattern.

INSTALLATION GUIDE

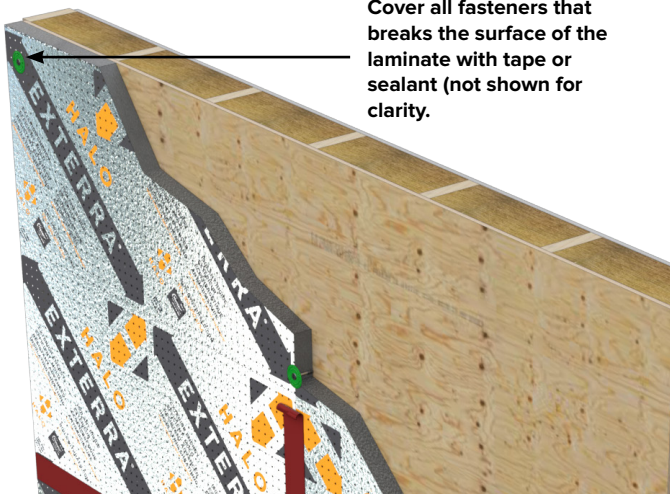

Cover all fasteners that breaks the surface of the laminate with tape or sealant (not shown for clarity).

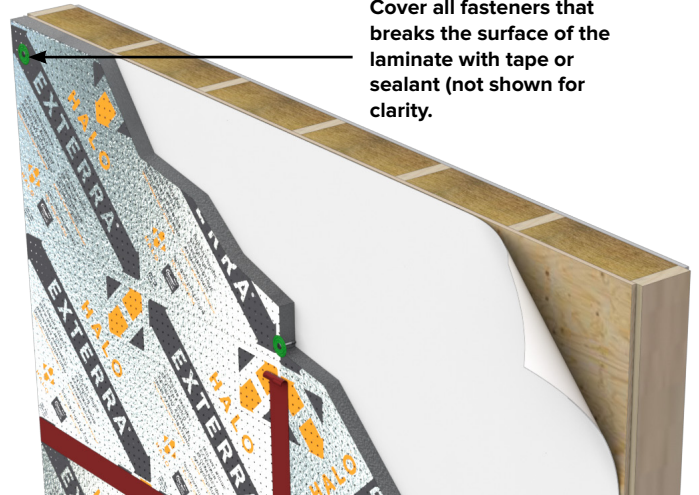

Cover all fasteners that breaks the surface of the laminate with tape or sealant (not shown for clarity).

Exterra against wood sheathing.
Taping joints and penetrations on Exterra is required to maintain water resistive properties.

Sheathing membrane between Exterra and wood sheathing.
Taping the joints of Exterra is optional.

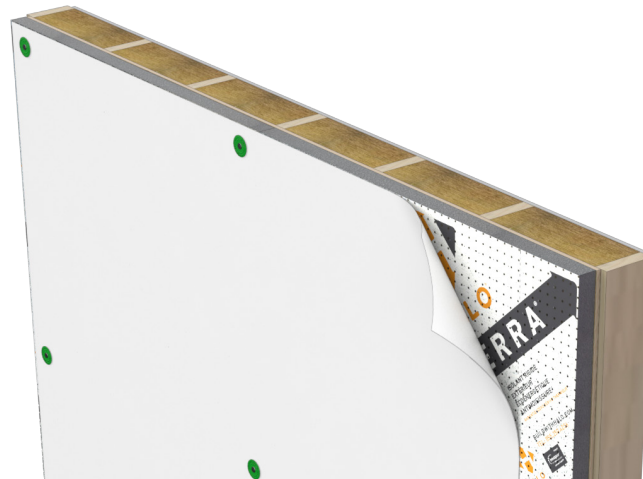

Exterra between sheathing membrane and wood sheathing.
Taping the joints of Exterra is not required.



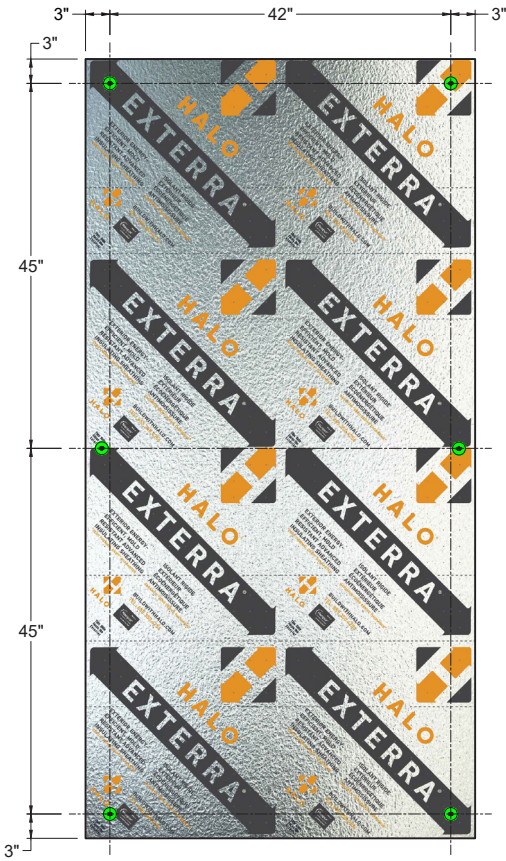

Nailing pattern - Vertical placement against wood sheathing (4'x8' Exterra board shown)

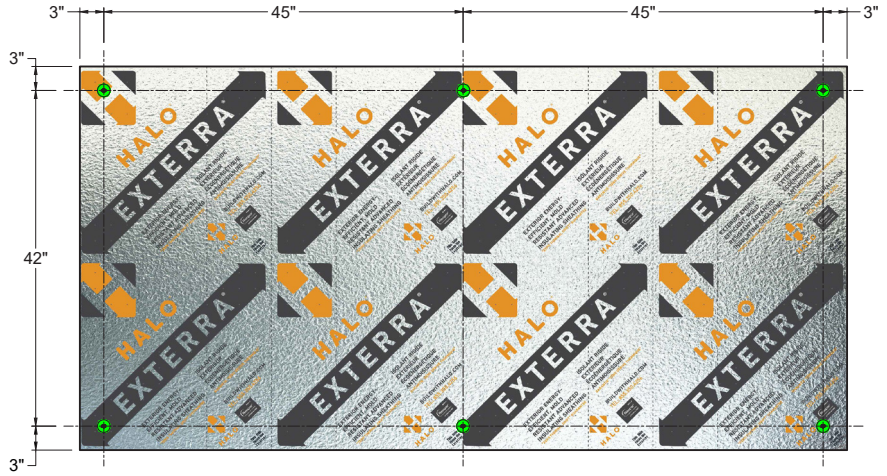

Nailing pattern - Horizontal placement against wood sheathing (4'x8' Exterra board shown)

TYPICAL NAILING PATTERNS OVER WOOD SHEATHING

INSTALLATION GUIDE





7.1.2 - Direct To Stud Assembly

Halo Exterra can be fastened directly to wood studs. In these cases, lateral bracing is provided by other methods such as diagonal metal bracing, or engineered bracing systems. Check local building codes to confirm if direct-to-stud installation is permitted and for approved lateral bracing methods

Exterra can be placed either horizontal or vertically. The vertical joints of Exterra boards should rest fully or halfway on a stud to ensure proper fastening to the stud.

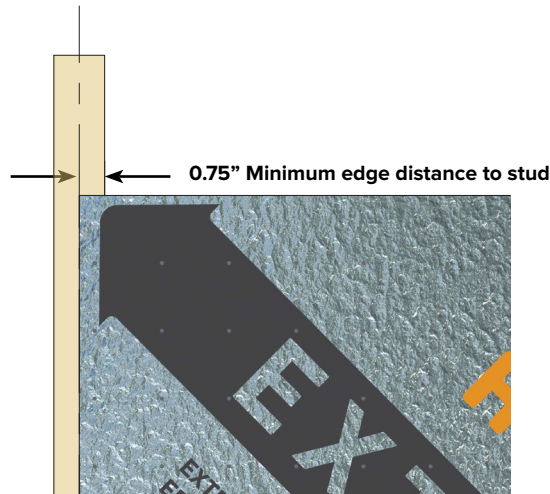

NOTE: In cases where transverse wind load resistance of the insulating sheathing is required, in accordance to SBCA FS 100, follow the fastener type and spacing requirements in Table 4 in "7.5 - FASTENER REQUIREMENTS FOR WIND LOADS - EXTERRA DIRECT TO WOOD studs" on page 40.

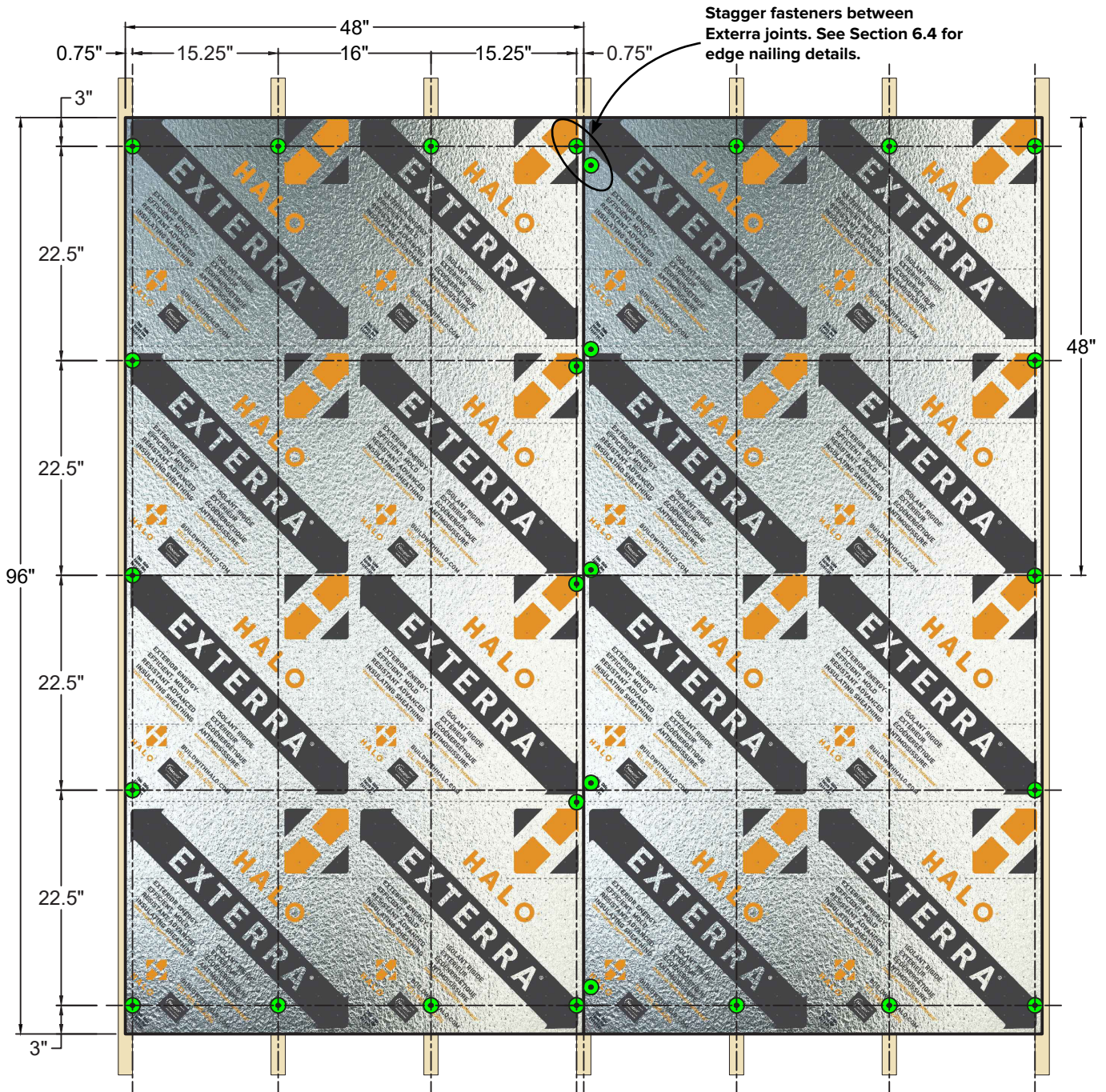

Nailing pattern - Vertical placement against 16" wood stud spacing (4'x8' Exterra boards shown). Use printed guidelines on Exterra boards to approximate vertical spacing of fasteners.

**TYPICAL NAILING PATTERN OVER OPEN STUD ASSEMBLY
VERTICAL INSTALLATION OVER 16" STUD SPACING**



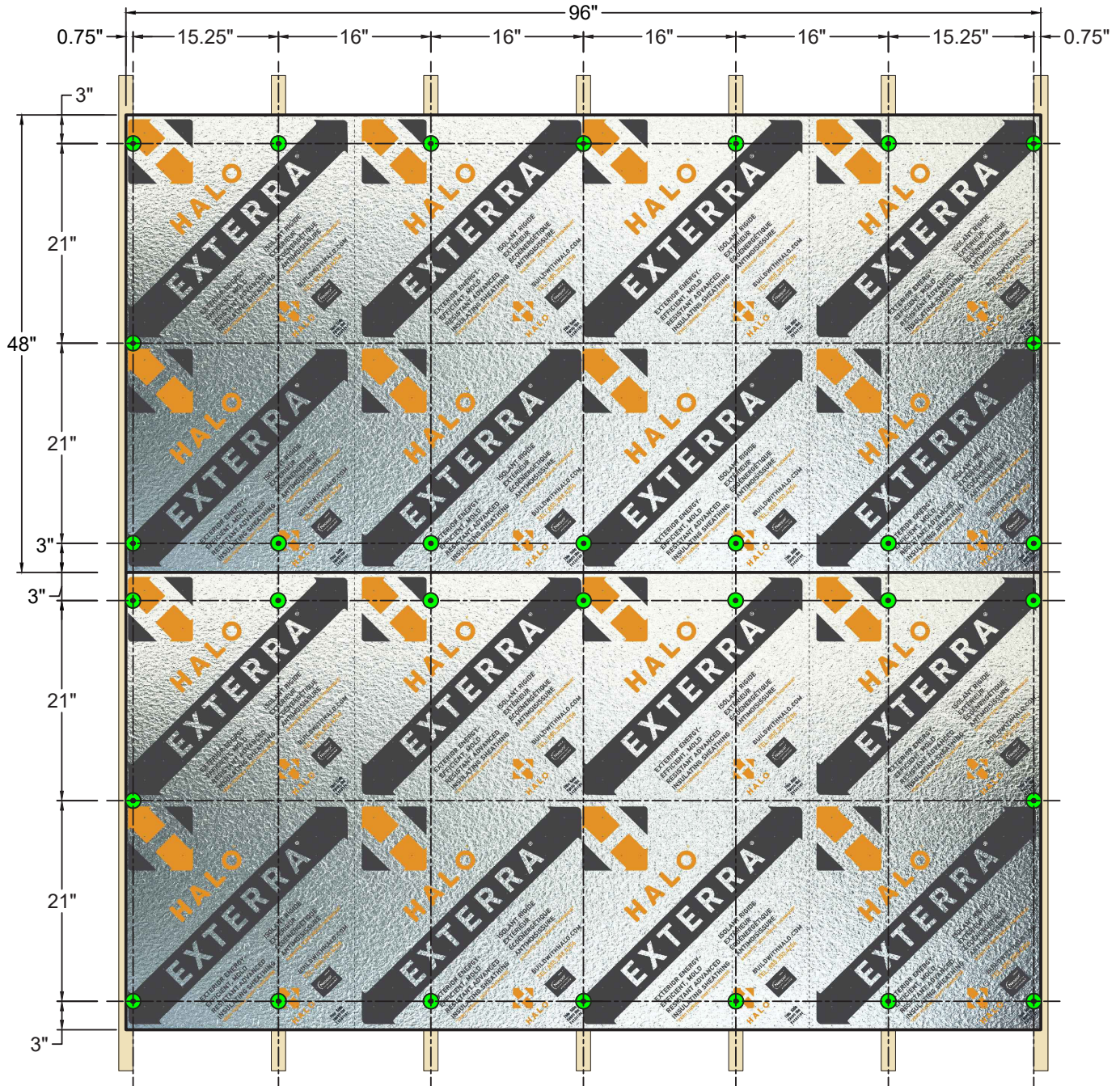

Nailing pattern - Horizontal placement against 16" wood stud spacing (4'x8' Exterra boards shown). Printed guidelines on Exterra boards can be used to locate studs.

**TYPICAL NAILING PATTERN OVER OPEN STUD ASSEMBLY
 HORIZONTAL INSTALLATION OVER 16" STUD SPACING**



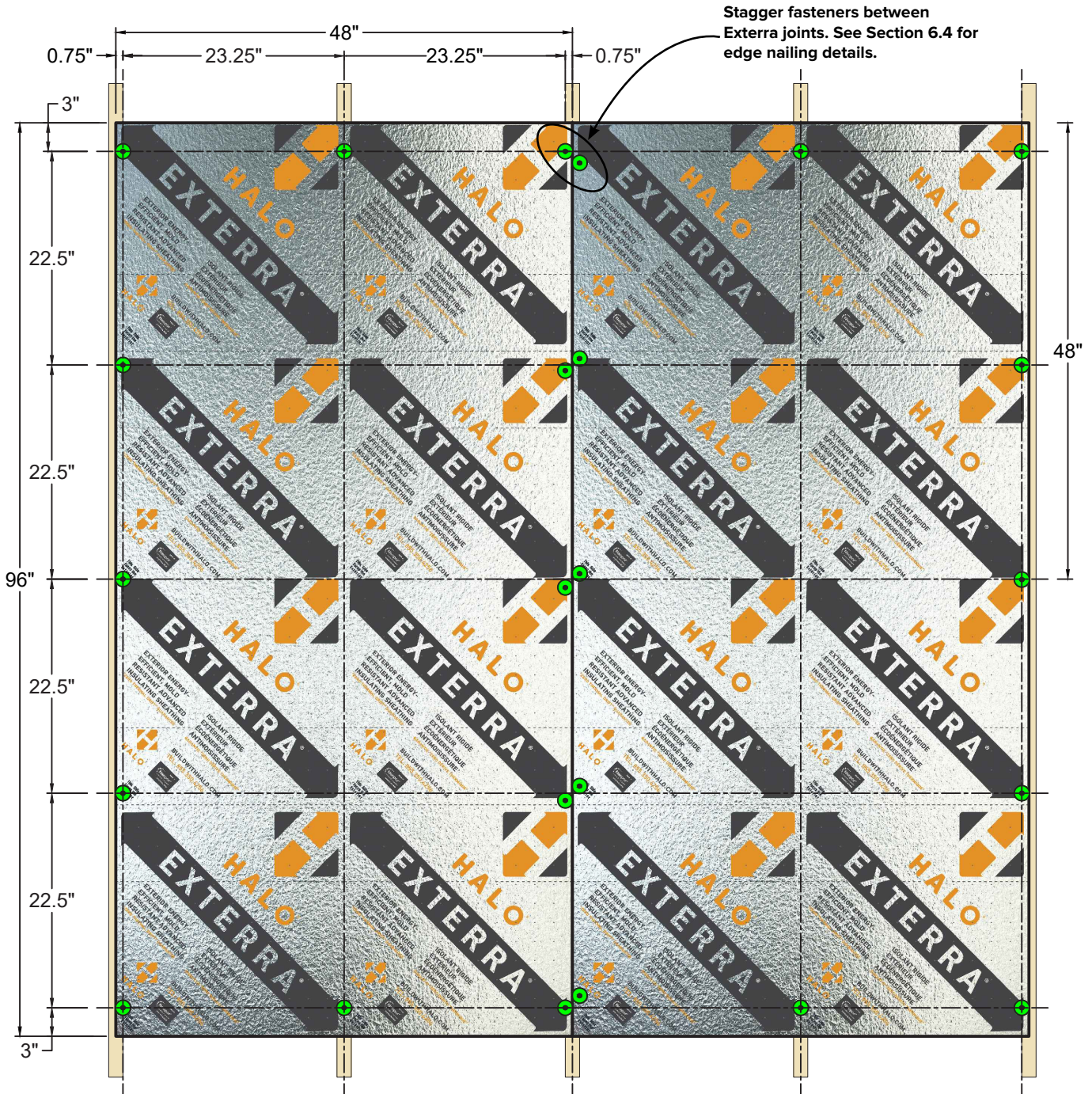

Nailing pattern - Vertical placement against 24" wood stud spacing (4'x8' Exterra boards shown). Use printed guidelines on Exterra boards to approximate vertical spacing of fasteners.

**TYPICAL NAILING PATTERNS OVER OPEN STUD ASSEMBLY
VERTICAL INSTALLATION OVER 24" STUD SPACING**



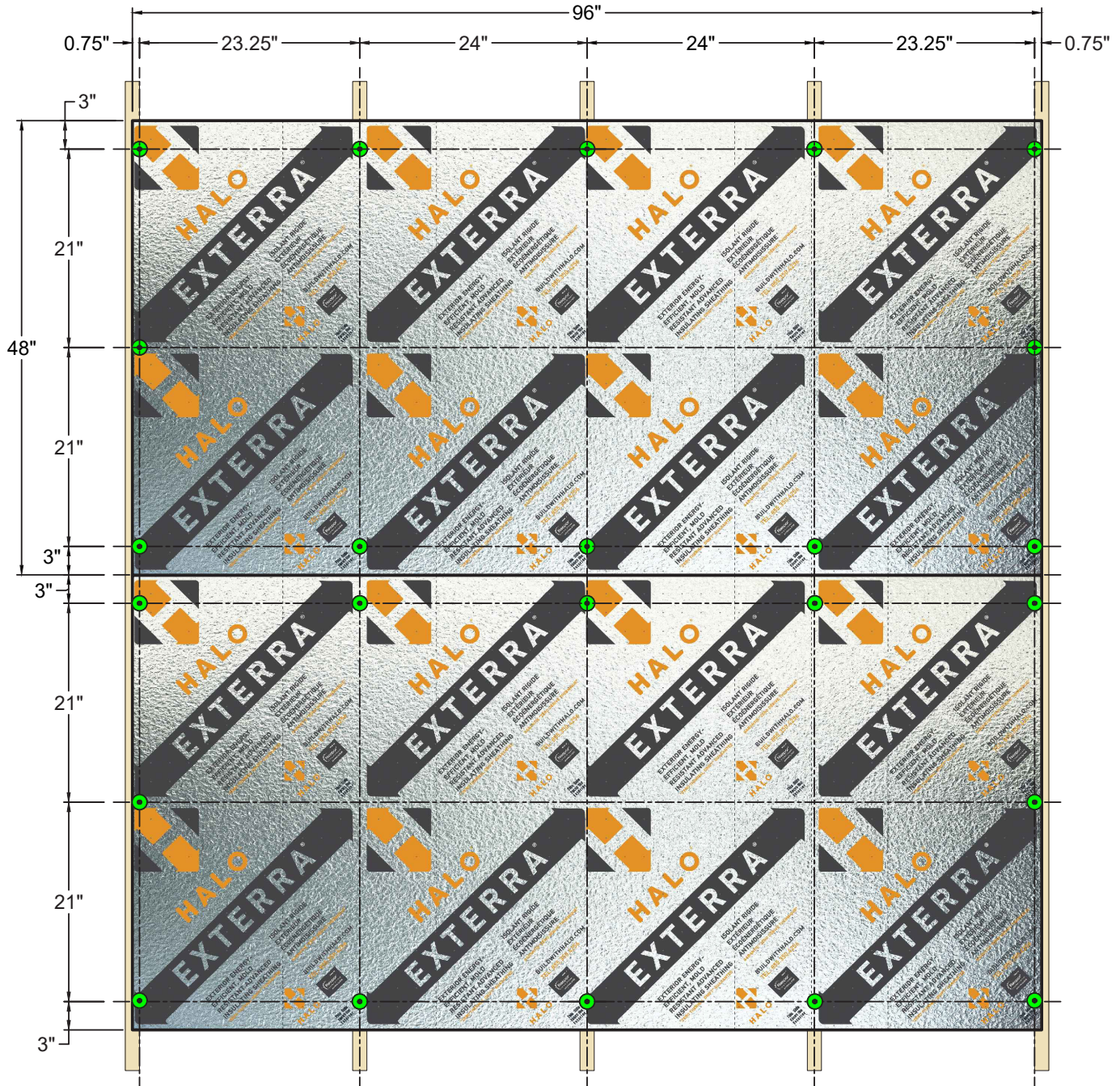

Nailing pattern - Horizontal placement against 24" wood stud spacing (4'x8' Exterra boards shown). Printed guidelines on Exterra boards can be used to locate studs.

**TYPICAL NAILING PATTERNS OVER OPEN STUD ASSEMBLY
 HORIZONTAL INSTALLATION OVER 24" STUD SPACING**



7.2 - NAILING PATTERNS FOR PREFABRICATED WALL ASSEMBLIES

When Exterra is installed in a factory-built wall system additional fasteners are required to secure Exterra boards due to handling and transportation of the prefabricated wall assembly.

Since Exterra boards are non-structural, the wall assembly must be properly braced, as required by building codes or structural specifications.

Before cladding is installed over Exterra inspect the Exterra boards for any visible signs of damage, and to ensure all taped joints and penetrations are properly adhered to Exterra.

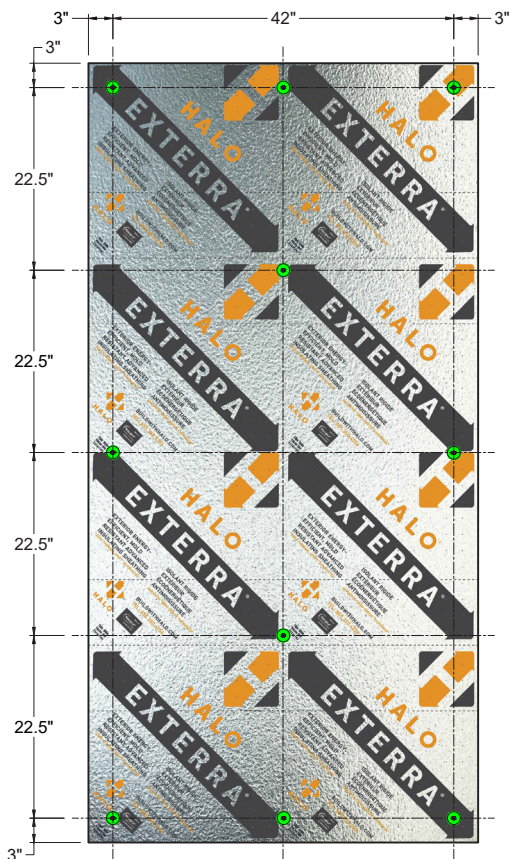

Nailing pattern - Vertical placement against wood sheathing (4'x8' Exterra board shown)

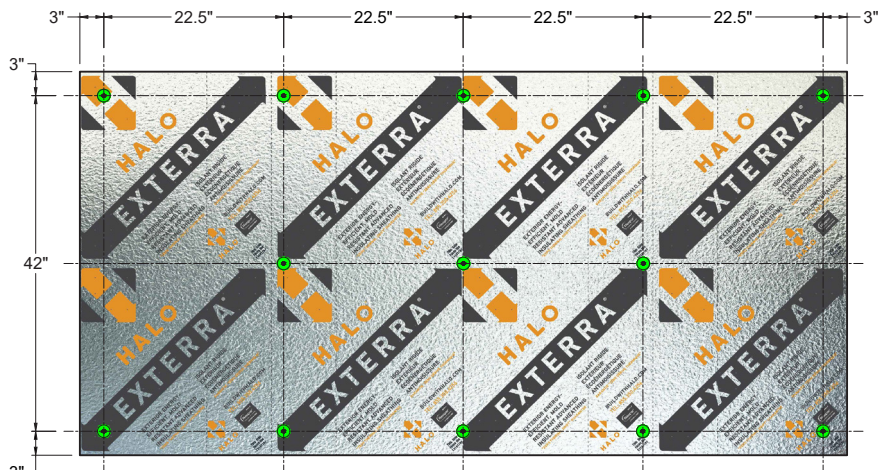

Nailing pattern - Horizontal placement against wood sheathing (4'x8' Exterra board shown)

TYPICAL NAILING PATTERNS OVER WOOD SHEATHING PREFABRICATED WALL ASSEMBLIES





7.2 - NAILING PATTERNS FOR PREFABRICATED WALL ASSEMBLIES CONT.

INSTALLATION GUIDE

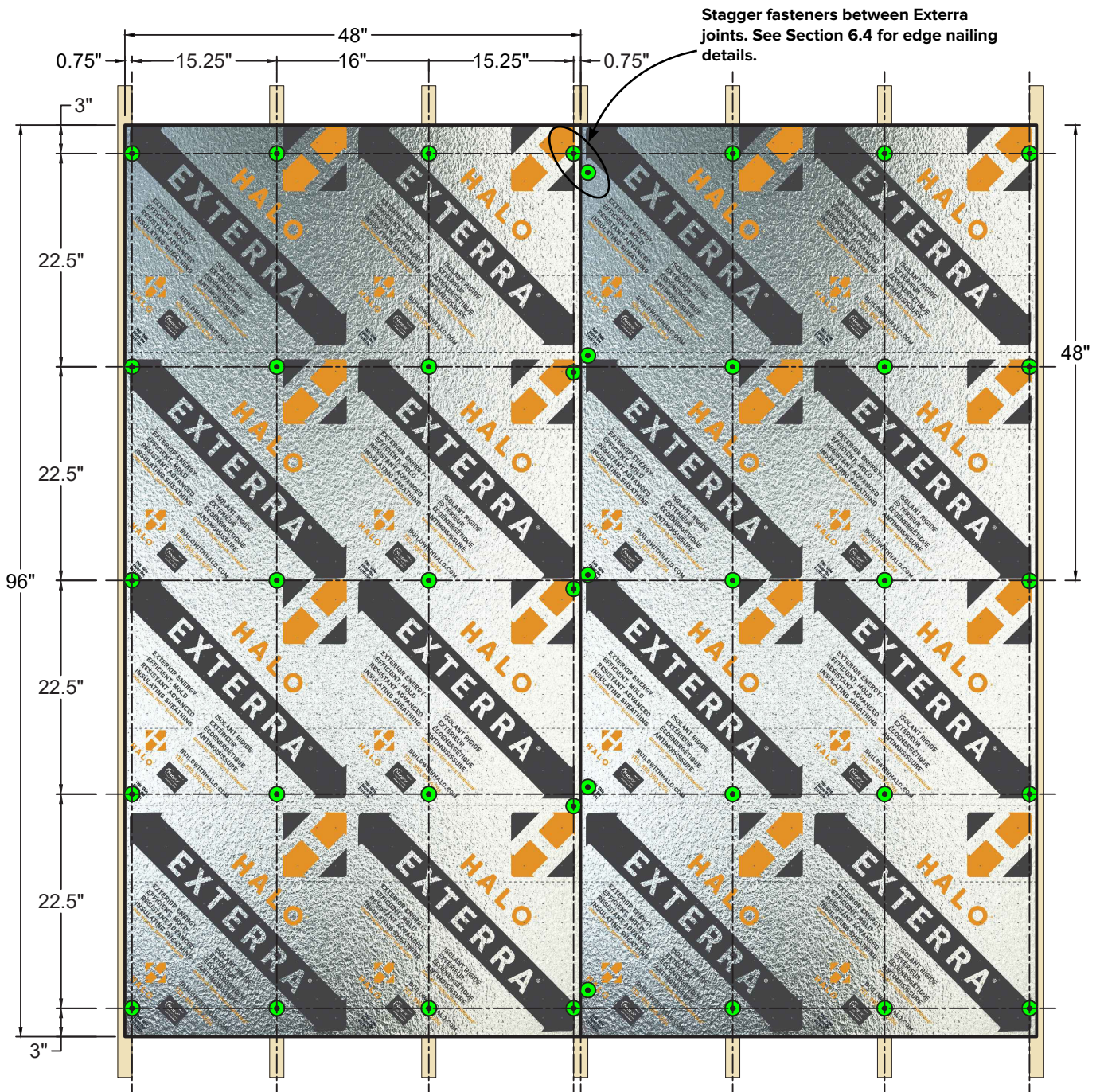

Nailing pattern - Vertical placement against 16" wood stud spacing (4'x8' Exterra boards shown). Use printed guidelines on Exterra boards to approximate vertical spacing of fasteners.

PREFABRICATED WALL ASSEMBLIES
TYPICAL NAILING PATTERN OVER OPEN STUD ASSEMBLY
VERTICAL INSTALLATION OVER 16" STUD SPACING



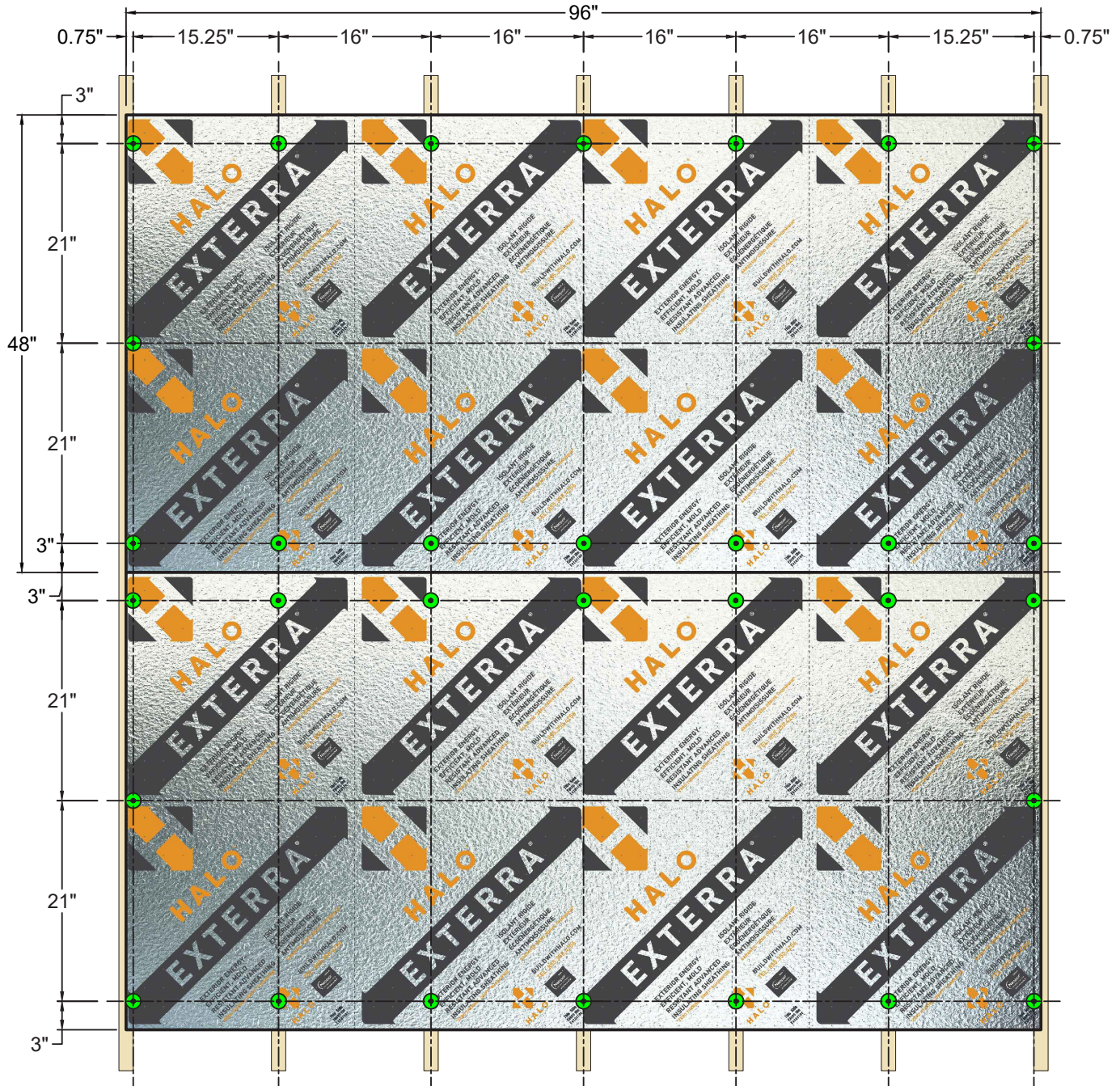

INSTALLATION GUIDE

Nailing pattern - Horizontal placement against 16" wood stud spacing (4'x8' Exterra boards shown). Printed guidelines on Exterra boards can be used to locate studs.

**PREFABRICATED WALL ASSEMBLIES
TYPICAL NAILING PATTERN OVER OPEN STUD ASSEMBLY
HORIZONTAL INSTALLATION OVER 16" STUD SPACING**



7.2 - NAILING PATTERNS FOR PREFABRICATED WALL ASSEMBLIES CONT.

INSTALLATION GUIDE

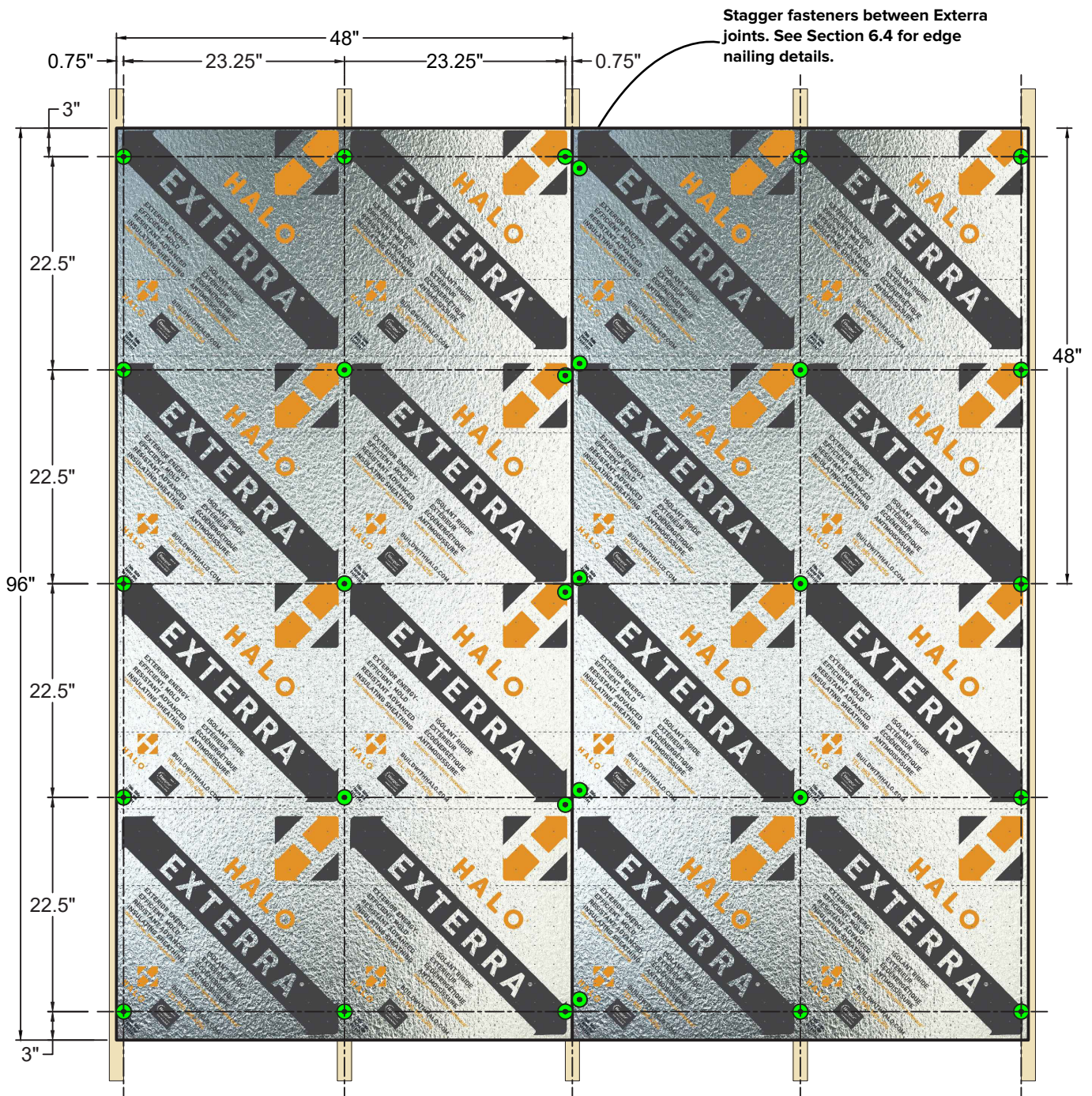

Nailing pattern - Vertical placement against 24" wood stud spacing (4'x8' Exterra boards shown). Use printed guidelines on Exterra boards to approximate vertical spacing of fasteners.

PREFABRICATED WALL ASSEMBLIES
TYPICAL NAILING PATTERN OVER OPEN STUD ASSEMBLY
VERTICAL INSTALLATION OVER 24" STUD SPACING



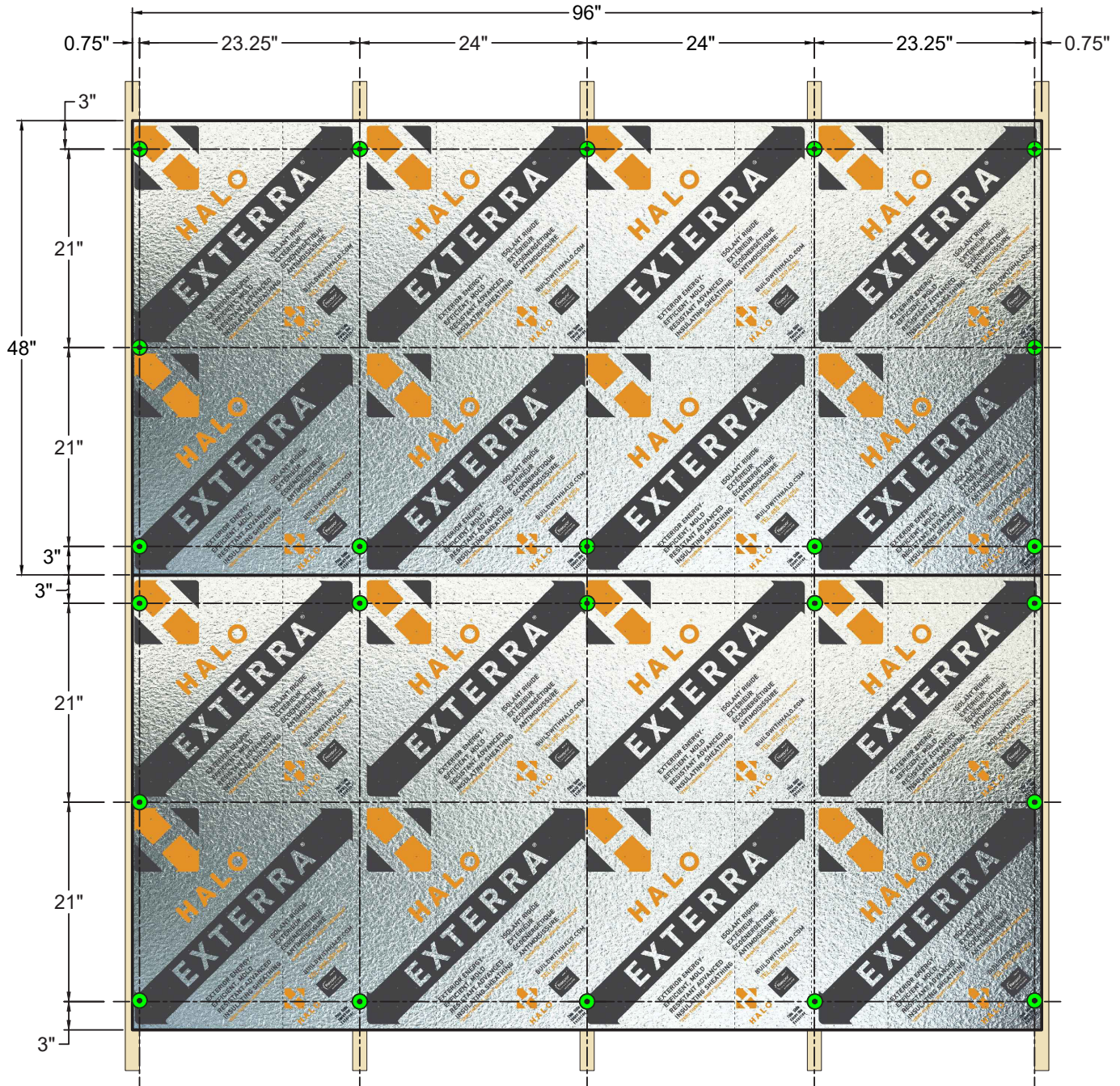

INSTALLATION GUIDE

Nailing pattern - Horizontal placement against 24" wood stud spacing (4'x8' Exterra boards shown). Printed guidelines on Exterra boards can be used to locate studs.

**PREFABRICATED WALL ASSEMBLIES
TYPICAL NAILING PATTERN OVER OPEN STUD ASSEMBLY
HORIZONTAL INSTALLATION OVER 24" STUD SPACING**



THE ADVANCED GRAPHITE INSULATION SYSTEM
BUILDWITHHALO.COM





7.3 - RECOMMENDED FASTENER LENGTHS

7.3.1 - Over Wood Sheathing

Fasteners should be long enough to penetrate Exterra and completely through the wood sheathing substrate.

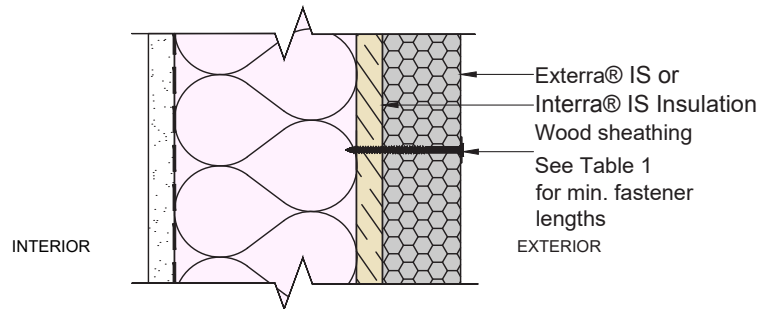

Table 1: Minimum Fastener Length into Wood Sheathing

Exterra Thickness	Minimum Fastener Lengths		
	1/2" Wood Sheathing	5/8" Wood Sheathing	3/4" Wood Sheathing
9/16" or 5/8"	1 1/8"	1 1/4"	1 3/8"
1"	1 1/2"	1 5/8"	1 3/4"
1 1/2"	2"	2 1/8"	2 1/4"
2"	2 1/2"	2 5/8"	2 3/4"

7.3.2 - Direct To Wood Stud Assembly

Fasteners should be long enough to penetrate Exterra and at least 1" into the framing studs or blocking.

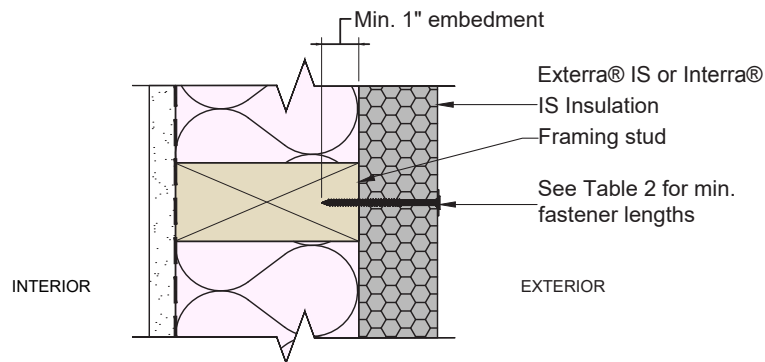
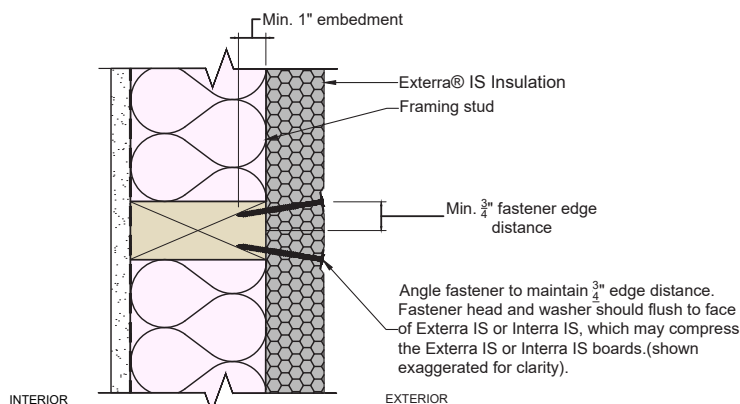

Table 2: Exterra Fastened Direct to Framing Studs

Exterra Thickness	Minimum Fastener Lengths
9/16" or 5/8"	1 5/8"
1"	2"
1 1/2"	2 1/2"
2"	3"

To maintain minimum 1" edge distance at vertical joints angle the fasteners.



INSTALLATION GUIDE





7.4 - FASTENER AND STRAPPING TABLES

The following tables provide recommended fastener size, spacing and strapping for light, medium and heavy cladding weights. 7.4 - Fastener And Strapping Tables

Cladding Weights

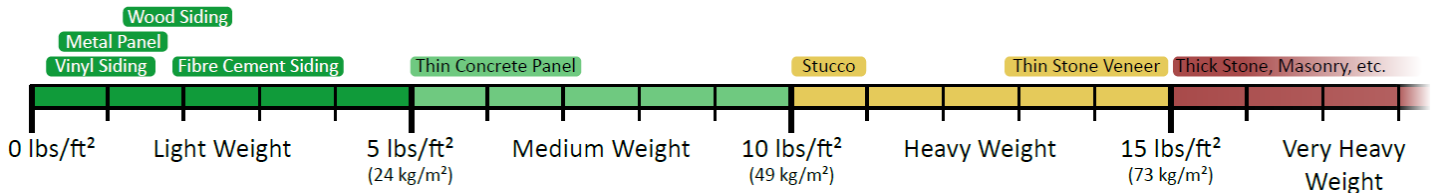

Source: R22+ Effective Walls in Residential Construction in British Columbia, November 2017

Table 3: Fastener and Strapping Requirements

Light Weight Cladding Below 5 lbs/ft² (0.24 kPa)

Stud Spacing o.c.	Maximum Halo Exterra Thickness	Maximum Vertical Screw Spacing	Minimum Screw Size	Minimum Screw Embedment ¹	Minimum Strapping Size
16"	2 1/8"	24"	#10	2.5"+ Exterra Thickness	3/4" x 2 1/2"
24"		16"			

Medium Weight Cladding Between 5 lbs/ft² and 10 lbs/ft² (0.24 kPa to 0.48 kPa)

Stud Spacing o.c.	Maximum Halo Exterra Thickness	Maximum Vertical Screw Spacing	Minimum Screw Size	Minimum Screw Embedment ¹	Minimum Strapping Size
16"	2 1/8"	16"	#12	2.5"+ Exterra Thickness	3/4" x 2 1/2"
24"		12"			

Heavy Weight Cladding Between 10 lbs/ft² and 15 lbs/ft² (0.48 kPa to 0.72 kPa)

Stud Spacing o.c.	Maximum Halo Exterra Thickness	Maximum Vertical Screw Spacing	Minimum Screw Size	Minimum Screw Embedment ¹	Minimum Strapping Size
16"	2 1/8"	16"	#14	2.5"+ Exterra Thickness	3/4" x 2 1/2"
24"					

Notes:

- The total minimum screw length includes the Exterra thickness plus 2.5" (64 mm), which consists of a 1" (25 mm) embedment length, 3/4" (19 mm) wood sheathing, and 3/4" (19 mm) wood strapping. The screw length may be reduced by 3/4" (19 mm) if Exterra is installed directly onto wood studs.
- Install strapping at every stud location to match the stud spacing shown in the tables.
- These tables are adapted from R22+ Effective Walls in Residential Construction in British Columbia, November 2017, with modifications to suit the Halo Exterra Installation Guide.
- These tables apply to wood frame assemblies in low-rise buildings under three storeys. Larger buildings may face higher wind loads and may require project-specific design.
- For wall assemblies with lightweight cladding and up to 2" of exterior insulation, a drain mat rainscreen product can be used instead of strapping where suitable, with fasteners secured directly to the wall framing. Confirm product suitability and fastening configurations with both the drain mat and cladding manufacturers.

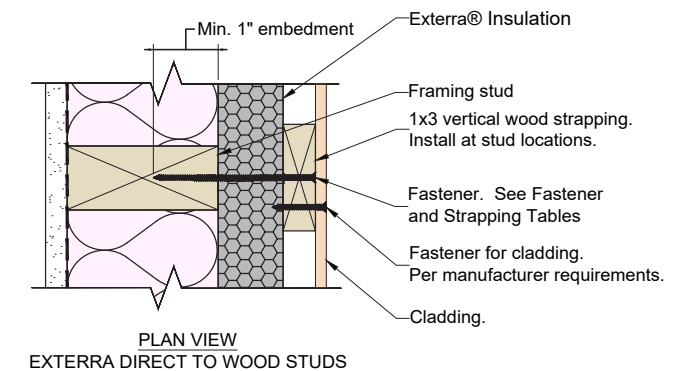
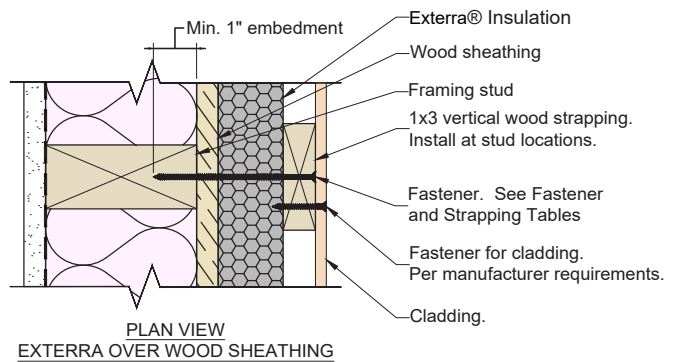

INSTALLATION GUIDE



7.5 - FASTENER REQUIREMENTS FOR WIND LOADS - EXTERRA DIRECT TO WOOD STUDS

When Exterra is installed directly on wood studs, transverse wind load resistance of Exterra may be required per SBCA FS 100. Check with local building codes. In such cases, follow the fastener type and spacing requirements in Table 4 for the specified wind loads.

Table 4: Allowable Wind Pressure Resistance and Wind Pressure Loads - Exterra Direct to Wood Studs

Exterra Thickness ²	Exterra Allowable Design Wind Pressure Resistance (PSF) ^{1, 8}	Minimum Fastener Type ¹⁰	Minimum Fastener Spacing ⁹	Components and Cladding Design Wind Pressure Loads (PSF) ^{3, 4, 6}								
				Design Wind Speed (mph, gust) / Exposure ⁷								
				85/B	90/B	100/B 85/C	110/B 90/C	120/B 100/C	130/B 110/C	140/B 120/C	150/B 130/C	
9/16"	7.3	2" x 0.113" Plastic Cap Ring Shank Nails with 1" Round Cap	16" o.c. along perimeter, 16" o.c. field.	☑	-	-	-	-	-	-	-	-
5/8"	8.9		22.5" o.c. vertically, 16" o.c. horizontally along perimeter.	☑	☑	-	-	-	-	-	-	-
1"	17.9		22.5" o.c. vertically, 16" o.c. horizontally along perimeter.	☑	☑	-	-	-	-	-	-	-
1.5"	31.2	3" x 0.113" Plastic Cap Ring Shank Nails with 1" Round Cap	22.5" o.c. vertically, 16" o.c. horizontally along perimeter.	☑	☑	☑	☑	☑	☑	☑	-	-
2"	53.9			☑	☑	☑	☑	☑	☑	☑	☑	☑

SI: 1 in = 25.4, 1 psf = 0.0479 kPa, 1 mph = 1.61 km/h

- Values are calculated allowable wind pressure resistance of Exterra based on tests conducted in accordance with ANSI/SBCA FS 100-12, Standard Requirements for Wind Pressure Resistance of Foam Plastic Insulating Sheathing Used in Exterior Wall Covering Assemblies. As required by FS 100-12, a safety of factor of 1.5 was used, pressure equalization factor of 0.9 for allowable wind pressures less than or equal to 30 psf. Otherwise a value of 1.0 was used.
- Exterra thickness 9/16" to 1" requires interior finish of at least 1/2" thick gypsum wall board (ASTM C1396) or any material of at least equivalent bending strength, rigidity and air permeability.
- Tabulated wind pressures are for mean roof heights not exceeding 30 feet (measured vertically from grade to middle of roof slope, enclosed buildings, and importance factor equal to 1.0. For other conditions of use, calculate wind load per bullet item 5.
- Where topographical effects occur (i.e., wind speed up due to hill-top exposure), wind loads shall be calculated per bullet item 5.
- Per bullet item 3 and 4, where required calculate wind load in accordance with the applicable building code or the ASCE 7 standard using an effective wind tributary area of 10 square feet.
- Tabulated wind pressures are for wall corner zones using an effective wind tributary are of 10 square feet. For lesser design wind pressures away from wall corner zones, refer to the applicable building code or the ASCE 7 standard.
- Wind exposure conditions: B = suburban/wooden terrain; C = open flat terrain; D = ocean/lake exposure. Refer to the applicable building code or the ASCE 7 standard for wind exposure descriptions.
- Listed values apply to positive wind pressure design, given that exterior cladding typically withstands negative pressure. Consult your cladding manufacturer to confirm wind pressure designs for cladding.
- Wall wood stud spacing is maximum 16 inches on center. All Exterra edges shall be supported by framing or blocking.
- Where wood strapping are installed over Exterra, strapping shall attach to wall framing. Strapping shall be minimum 3/4 inches. Increase nail length by 1 inch minimum.

INSTALLATION GUIDE



8.0 - INSPECTION & REPAIRS

Exterra is designed to be durable and flexible. However, inspecting the condition of installed Exterra boards prior to the attachment of cladding and/or strapping will ensure Exterra performs as designed to maintain a layer of continuous thermal insulation and a water resistive barrier .

Inspect installed Exterra boards sufficiently in advance of cladding or strapping placement to ensure

- seams are not broken
- joints, penetrations and perimeter are properly fastened and/or sealed
- damaged areas are marked and properly repaired.

It is important to repair any damaged sections of Halo Exterra to ensure a continuous panel of insulation and a complete water resistive barrier. In most circumstances repairing damaged Exterra boards simply requires application of tape, membrane, or sealant over the damaged section. If the laminate is severely damaged and/or sections of foam are missing, remove the damaged area and replace with a new piece of Halo Exterra. To connect the new piece to the existing foam board insulation apply tape, membrane or liquid sealant around the perimeter of the new piece of foam board insulation.

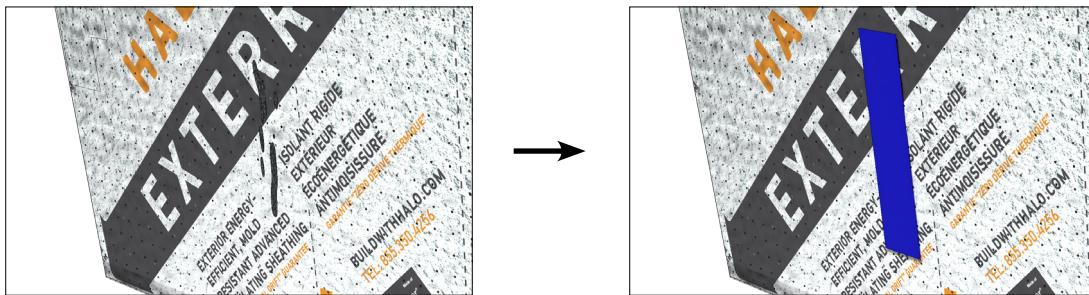

Apply tape, membrane or sealant over minor tears in the laminate.

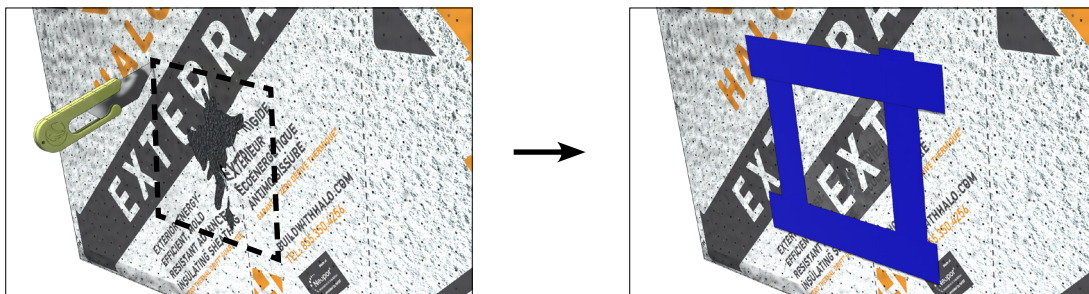

Replace any severely damaged laminate or foam sections. Use tape, membrane, or sealant around the perimeter to connect the new piece to the existing foam board insulation.





9.0 - EXAMPLE CAD DETAILS

Reference to “Logix Brands Ltd.,” “Logix,” “AMC Foam Technologies Inc.,” “Form Systems, Inc.,” “Perma R. Products, Inc.,” “2121361 Ontario Inc.” and/or “Beaver Plastics Ltd.” mean the manufacturer (the “Manufacturer”) selling the product(s) (the “Products”) referenced in the Title section of the drawing (the “Drawing”) to consumers (the “User”). The Manufacturer sells its Products “as is” and the contents of the Drawing are provided “as is”.

NO EXPRESS WARRANTIES ARE GIVEN. ALL WARRANTIES, EXPRESS, STATUTORY AND IMPLIED, INCLUDING BUT NOT LIMITED TO, WARRANTIES OF MERCHANTABILITY AND FITNESS FOR A PARTICULAR PURPOSE, ARE EXPRESSLY DISCLAIMED.

The User assumes all risks as to the use of the Products and/or the Drawing. The Drawing is to be used as a reference guide only. The User shall confirm the information contained in the Drawing meets local building codes and construction practices by consulting with local building officials and professionals, and determine if there are any additional building and/or construction requirements. Before use, the User should fully investigate the Products to enable informed choices as to suitability for a particular construction project and proper design and implementation. It is the User’s responsibility and obligation to ensure all work performed conforms to applicable building code and labour safety regulations governing the construction.

Additional details available on request. Logix Brands supports details in AutoCAD, Revit, and Sketchup formats.





9.1 - FLANGED WINDOW INSTALLED AGAINST WOOD SHEATHING

INSTALLATION GUIDE

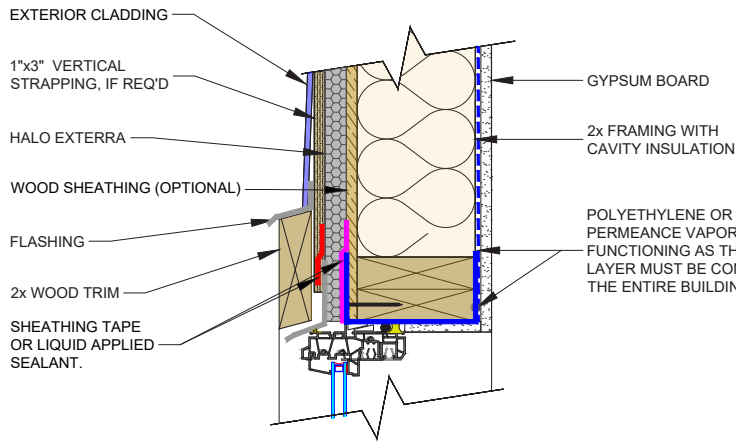

HALO HEADER DETAIL EXAMPLE

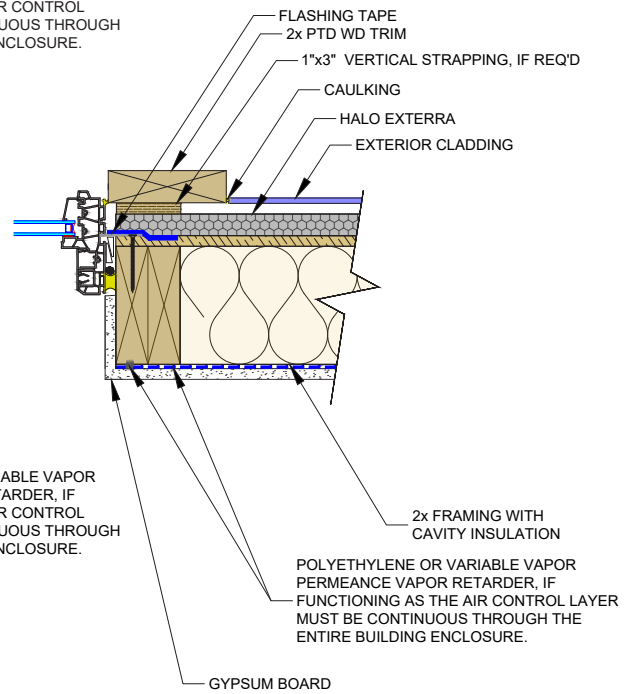

HALO JAMB DETAIL EXAMPLE

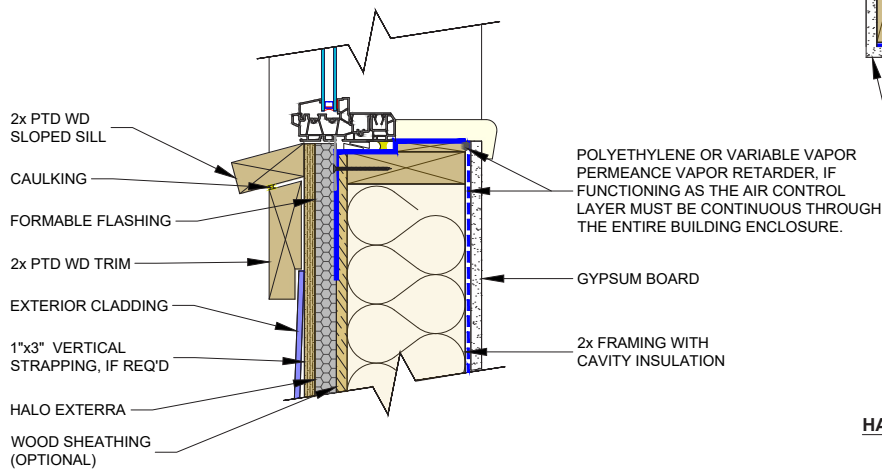

HALO SILL DETAIL EXAMPLE

The tables and drawings represented herein are believed to be accurate and conforming to current design and construction practices. However, the tables and drawings should be used as a reference guide only. The user shall check to ensure the drawing meets local building codes, design and construction practices by consulting local building officials and professionals, including any additional requirements. Logix reserves the right to make changes to the tables and drawings without notice and assumes no liability in connection with the use of the tables and drawings including modification, copying or distribution.





9.2 - FLANGED WINDOW INSTALLED AGAINST EXTERRA

INSTALLATION GUIDE

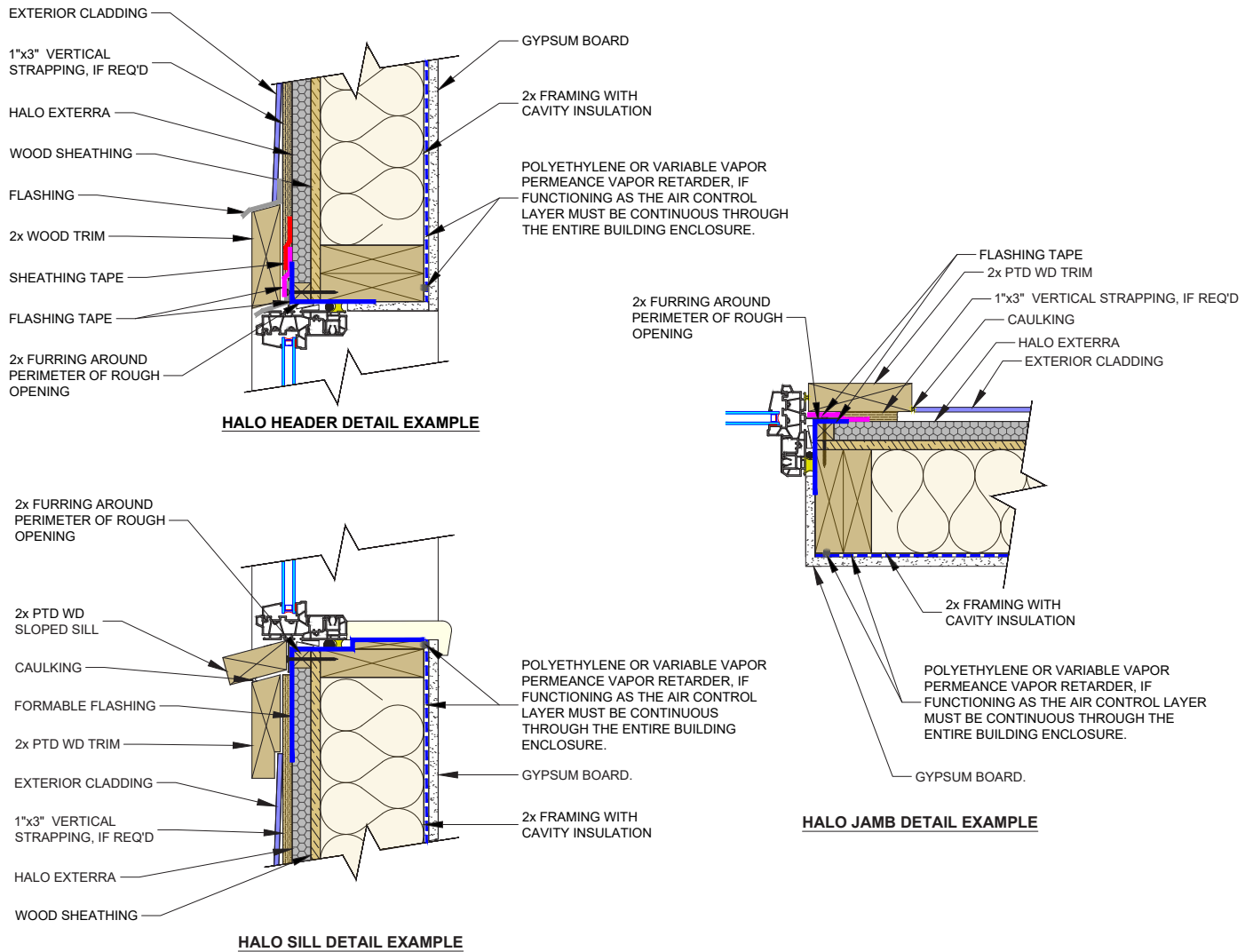

The tables and drawings represented herein are believed to be accurate and conforming to current design and construction practices. However, the tables and drawings should be used as a reference guide only. The user shall check to ensure the drawing meets local building codes, design and construction practices by consulting local building officials and professionals, including any additional requirements. Logix reserves the right to make changes to the tables and drawings without notice and assumes no liability in connection with the use of the tables and drawings including modification, copying or distribution.





9.3 - ROOF TRANSITION

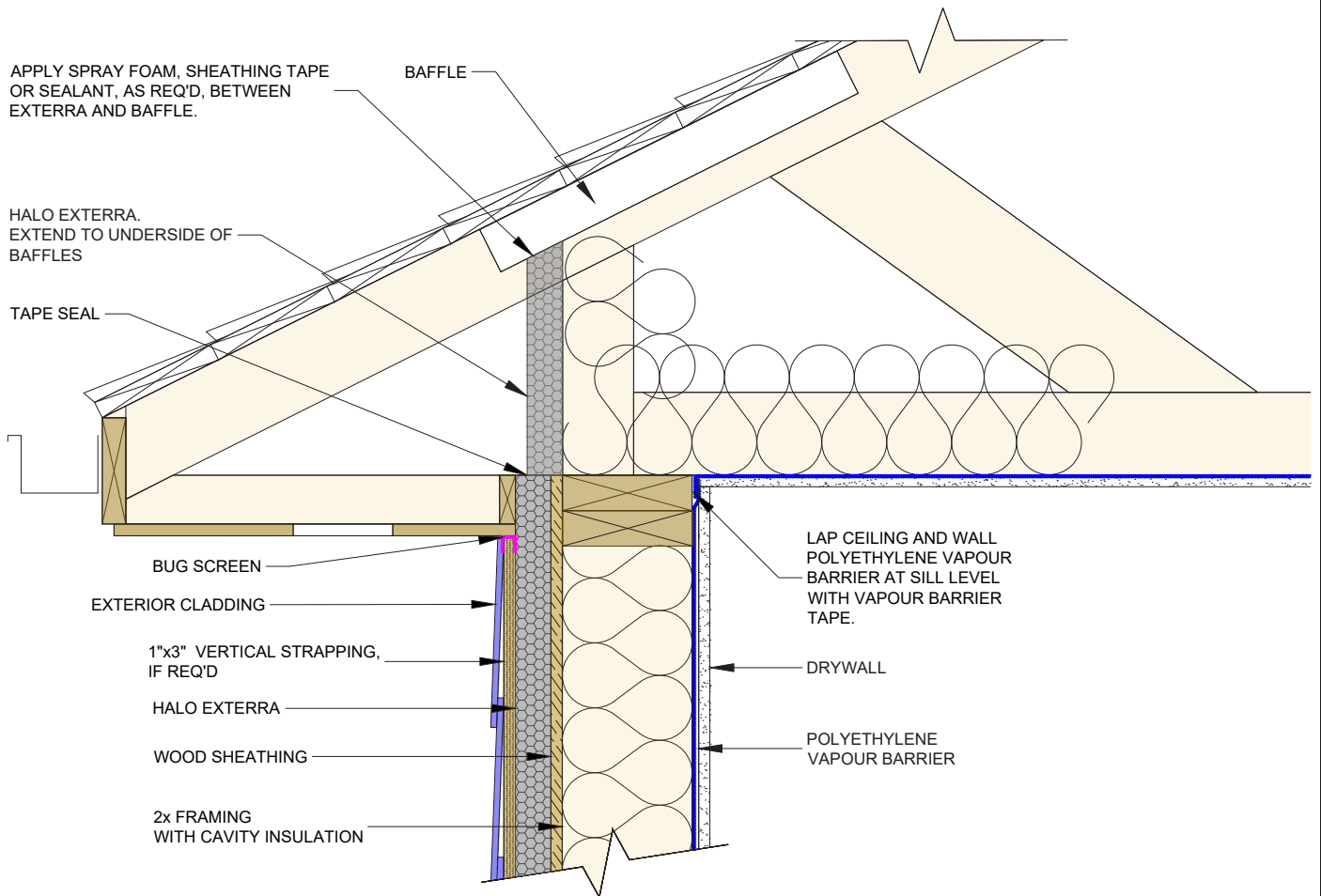

INSTALLATION GUIDE

The tables and drawings represented herein are believed to be accurate and conforming to current design and construction practices. However, the tables and drawings should be used as a reference guide only. The user shall check to ensure the drawing meets local building codes, design and construction practices by consulting local building officials and professionals, including any additional requirements. Logix reserves the right to make changes to the tables and drawings without notice and assumes no liability in connection with the use of the tables and drawings including modification, copying or distribution.





9.4 - TYPICAL WALL ASSEMBLY

INSTALLATION GUIDE

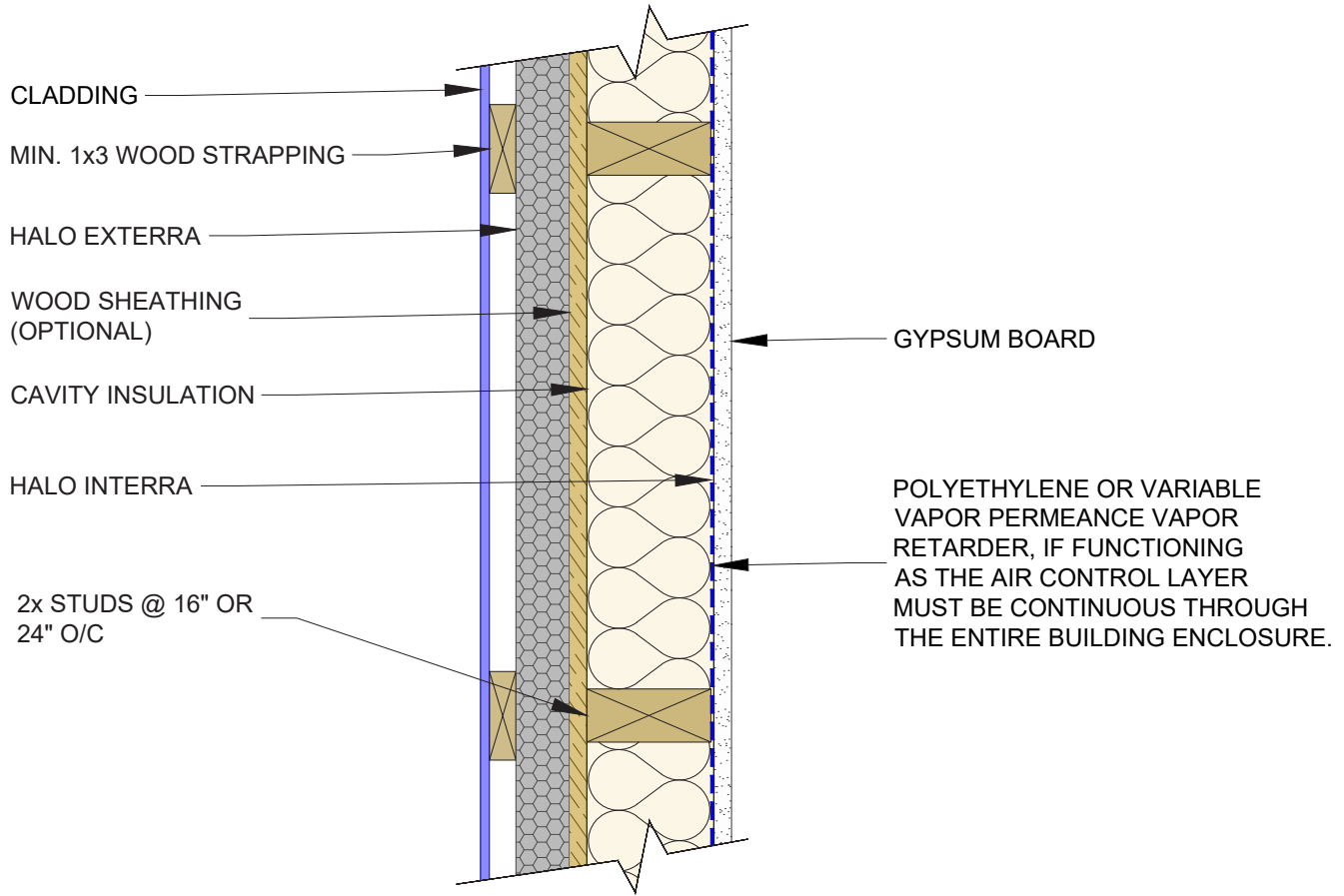

The tables and drawings represented herein are believed to be accurate and conforming to current design and construction practices. However, the tables and drawings should be used as a reference guide only. The user shall check to ensure the drawing meets local building codes, design and construction practices by consulting local building officials and professionals, including any additional requirements. Logix reserves the right to make changes to the tables and drawings without notice and assumes no liability in connection with the use of the tables and drawings including modification, copying or distribution.





9.5 - FLOOR TRANSITION

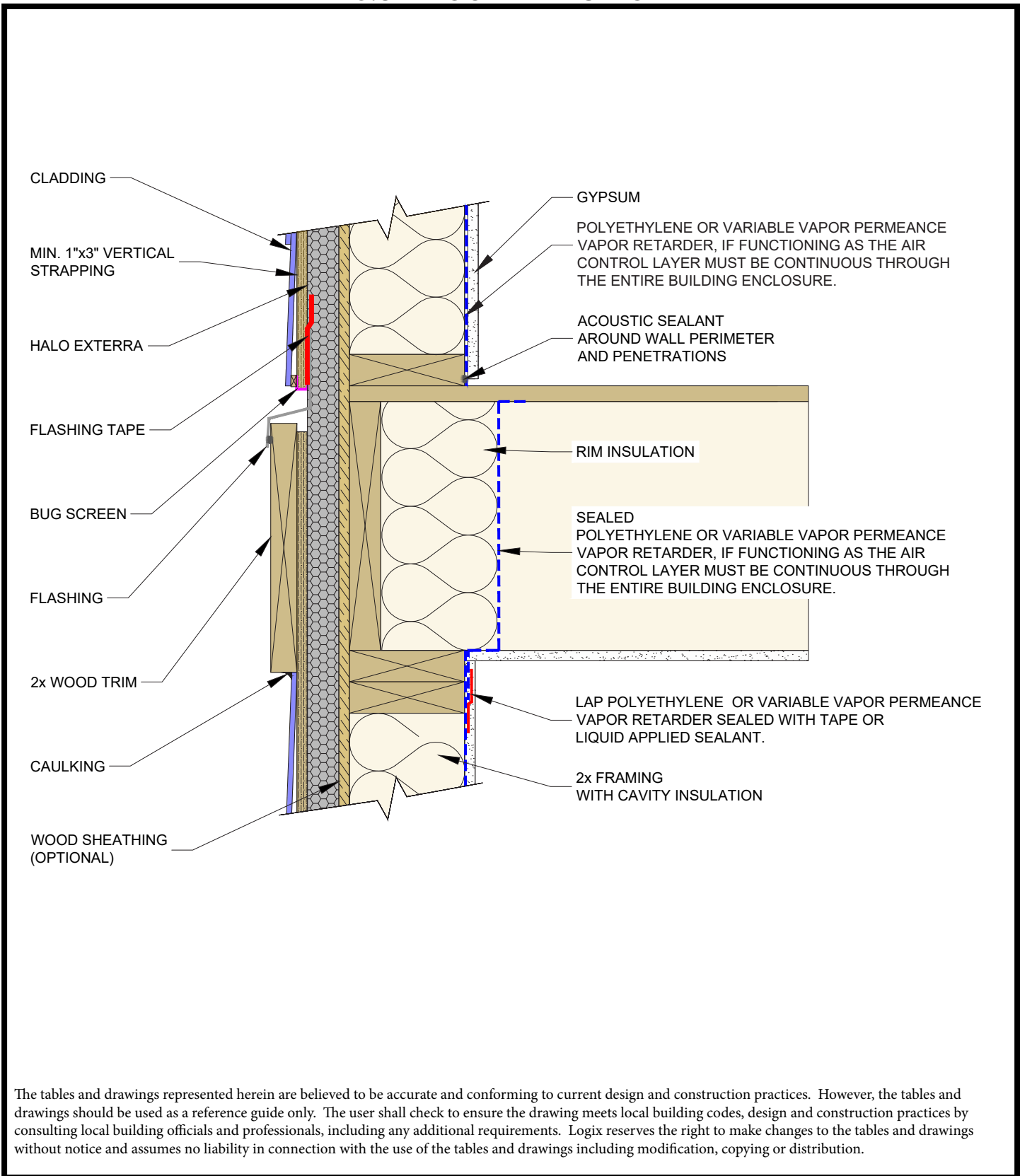

INSTALLATION GUIDE

The tables and drawings represented herein are believed to be accurate and conforming to current design and construction practices. However, the tables and drawings should be used as a reference guide only. The user shall check to ensure the drawing meets local building codes, design and construction practices by consulting local building officials and professionals, including any additional requirements. Logix reserves the right to make changes to the tables and drawings without notice and assumes no liability in connection with the use of the tables and drawings including modification, copying or distribution.



9.6 - FOUNDATION TRANSITION

INSTALLATION GUIDE

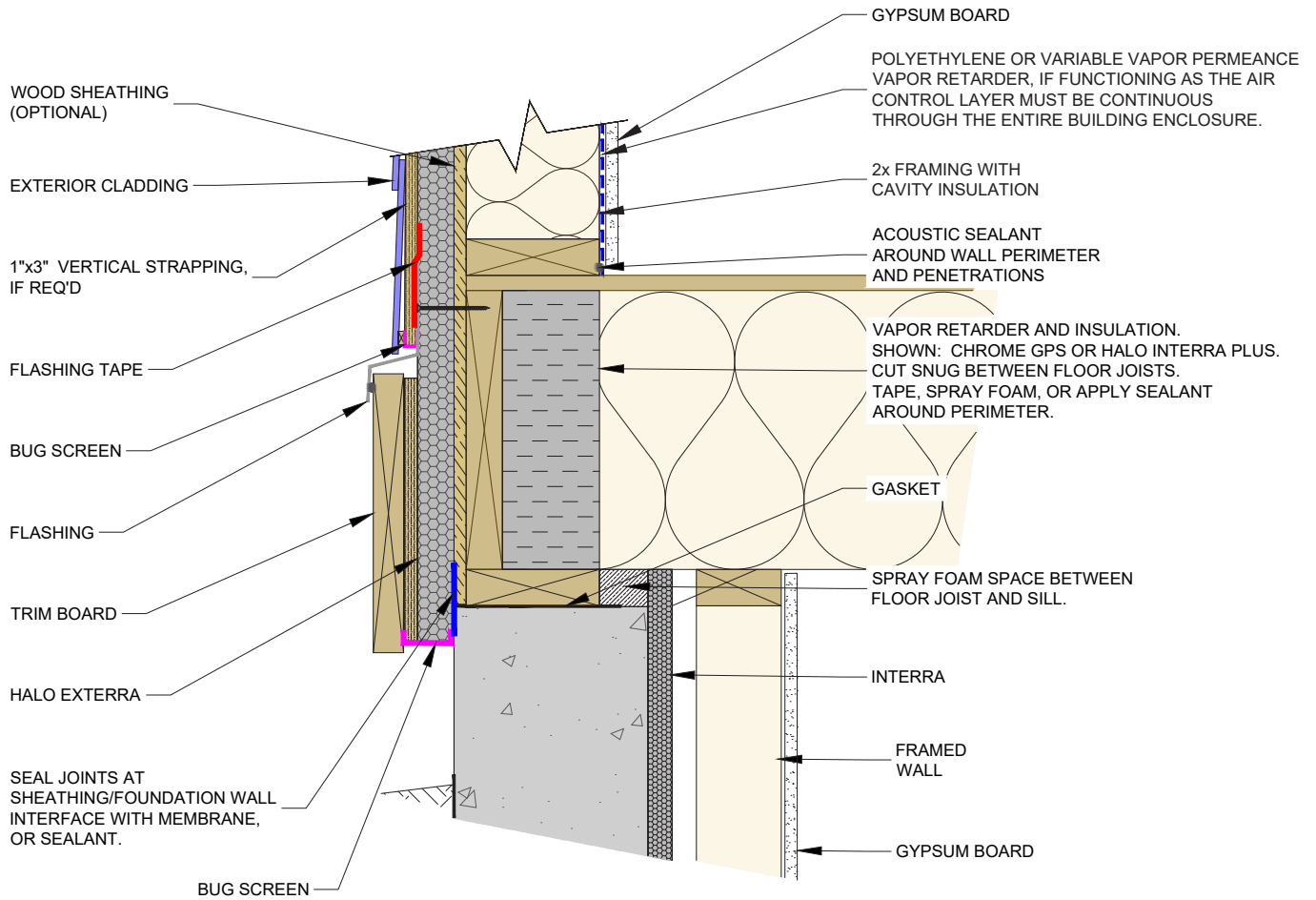

The tables and drawings represented herein are believed to be accurate and conforming to current design and construction practices. However, the tables and drawings should be used as a reference guide only. The user shall check to ensure the drawing meets local building codes, design and construction practices by consulting local building officials and professionals, including any additional requirements. Logix reserves the right to make changes to the tables and drawings without notice and assumes no liability in connection with the use of the tables and drawings including modification, copying or distribution.



CONNECT WITH A LOCAL MANUFACTURER

877.789.7622

35 Headingley Rd.
Headingley, MB R4H 0A8

888.453.5961

11581-272 St.
Acheson, AB T7X 6E9

6333 Unsworth Rd.
Chilliwack, BC V2R 5M3

800.860.3626

6753 Chestnut Ridge Rd.
Beach City, OH

800.647.6130

2604 Sunset Dr.
Grenada, MS 38901

106 Perma R Rd.
Johnson City, TN 37604

888.838.5038

330 Cain Drive
Haysville, KS 67060-2004

© Copyright Logix Brands Ltd. (2025) All rights reserved.

No part of the work contained herein as covered by this copyright may be reproduced or used in any form, or any means – graphic, electronic or mechanical, including without limitation photocopying. By using these products, you agree to assume all risks associated therewith. See LogixBrands.com/Disclaimer-General for a full copy of disclaimer.



info@buildwithHalo.com
BuildwithHalo.com

